

Models 5511 & 6611 Universal Scale Controller User's Manual

Version 2.96
May 2017

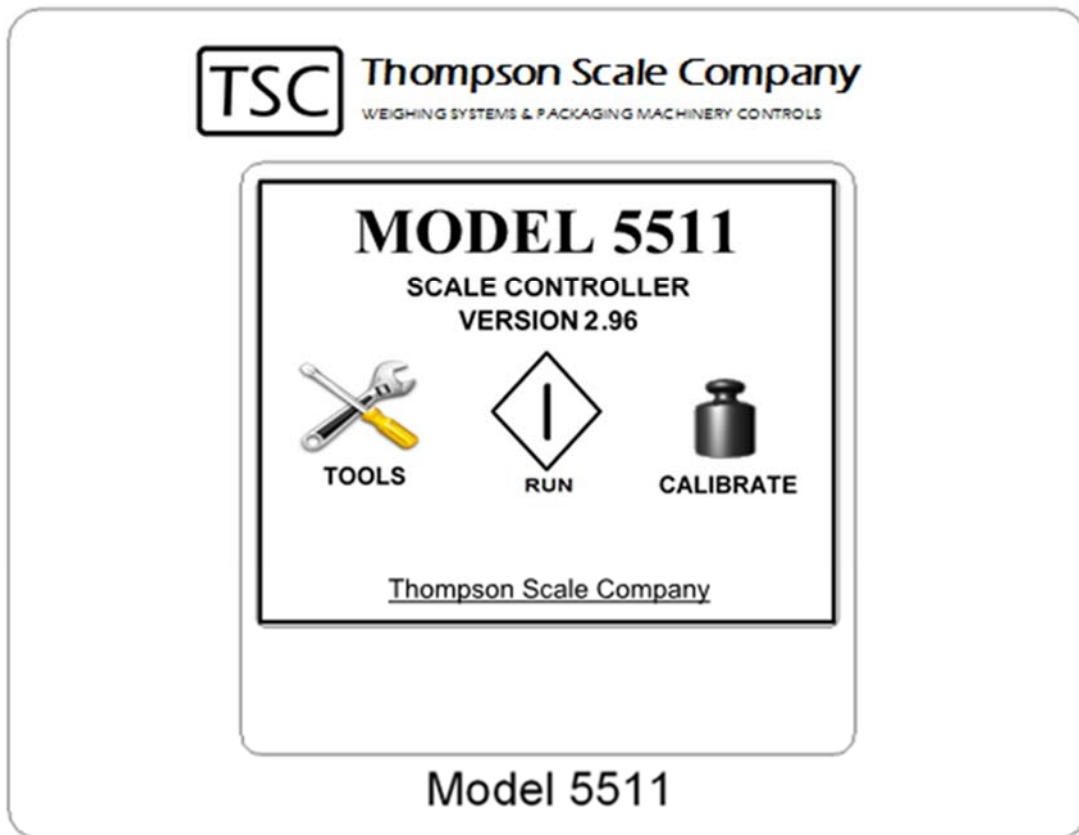

Thompson Scale Company • Houston TX • 713-932-9071 • thompsonscales.com

Contents

Important Installation Information	1
1.1 Model 5511 Controller	1
1.2 Model 6611 Controller	1
1.3 Electrical Requirements & Wiring Methods.....	1
1.3.1 AC Source Power Connection.....	1
1.3.2 DC Source Power Connection.....	2
1.3.3 Multiple Power Source Connections	2
1.4 Power Source Connection & Fusing	2
1.5 Input and Output Connections.....	2
1.5.1 Optional 120VAC Output Board	2
1.6 Load Cell Connections	3
1.7 Enclosure Mounting	3
1.8 Static Discharge Considerations	3
1.9 Considerations for use in Hazardous Environments	4
1.10 Condensation Considerations	4
1.11 Warning Statements.....	4
1.12 5511 Components	5
1.12.1 Processor Board for 6611.....	5
1.12.2 #815 CPU Board.....	5
1.12.3 #817 & #811 Primary Scale & I/O Board	5
1.12.4 #819 & #812 Secondary Scale & I/O Board	6
1.12.5 #820 & #814 Expander Output Board	7
1.12.6 #813 Display Interface Board	7
1.12.7 #816 Industrial Protocol Port	8
1.12.8 #821 Serial to Analog Dual Channel A-D Board.....	8
5511 & 6611 General Configuration	9
2.1 Creating password protection.....	9
2.2 Controller Configuration for Equipment Type.....	11
2.3 General Configuration Settings	12
2.3.1 Configuration 1 Settings.....	13
2.3.1.1 Set A-D Sample Rate.....	13
2.3.1.2 Set Filter Frequency.....	13
2.3.1.3 Set number of filter samples	13
2.3.1.4 Set decimal place.....	14

2.3.1.5 Set A-D gain	14
2.3.1.6 Set number of weight channels	14
2.3.1.7 Set max number of recipes	14
2.3.2 Configuration 2 Settings.....	15
2.3.2.1 Set display divisions	15
2.3.2.2 Set motion band.....	15
2.3.2.3 Set zero range	16
2.3.2.4 Set zero track band	17
2.3.2.5 Average Weight Setting	17
2.3.2.5.1 Number of samples to average.....	17
2.3.2.5.2 Include rejects in average	17
2.3.2.6 Set auto zero time.....	18
2.3.2.7 Set auto zero on or off	18
2.3.3 Test Routines.....	18
2.3.3.1 Rotating On Test	18
2.3.3.2 Keyboard On Test.....	19
2.3.3.3 Live I/O Status Screen	19
2.3.3.4 Read Serial EEPROM	20
2.3.3.5 Calibration Factors	20
2.3.3.6 Checkweigher Test	20
2.3.3.7 BBRAM Test.....	21
2.3.3.8 4-20mA Test	21
Calibration.....	23
3.1 Calibration Screen	23
3.2 Calibration Errors	27
Cannot Zero Scale	27
No Test Weight on Scale	27
Span at Either Min or Max	27
Checkweigher Configuration.....	29
4.1. Checkweigher type.....	30
4.1.1 Normal Mode Checkweigher	30
4.1.2 Manifest Mode Checkweigher	30
4.1.3 Static Mode Checkweigher	30
4.1.4 Dual Target Mode Checkweigher.....	30
4.2 Set number of photo-eyes	31

4.2.1 Number of Photo Eyes.....	31
4.2.1.1 One Photo Eye	32
4.2.1.2 Two Photo Eyes	32
4.2.1.2.1 Three Photo-Eyes Option	32
4.2.1.3 Empty Bag Reject.....	33
4.2.1.4 Bag Reject.....	33
4.2.1.5 Photo Eye Response	33
4.2.1.6 Photo Eye Response Time	33
4.3 Configure Reject Outputs	34
4.4 Initialize Audit Trail.....	35
4.5 Set Number of Zones.....	35
4.6 Feedback.....	35
4.6.1 Feedback Include Rejects	36
4.6.2 Set Pulse Feedback Weight	36
4.6.3 Set Max Number of Pulses	36
4.6.4 Checkweigher Recipe with Feedback	36
4.6.4.1 Set Feedback Sample Count	36
4.6.4.2 Set Feedback Sample Frequency.....	37
4.7 Configuring Global Settings	37
4.7.1 Set Time & Date.....	37
4.7.2 Set Reject Times	38
4.7.3 Set Motor Parameters.....	38
4.7.3.1 Cool Muscle Motor Settings.....	38
4.7.3.1.1 Set Conveyor Speed.....	39
4.7.3.1.2 Set Acceleration.....	39
4.7.3.1.3 Toggle Motor Direction	39
4.7.3.1.4 Initialize Motor	39
4.7.3.1.5 Change Motor to Pulse Roller	39
4.7.3.1.6 Set Auxiliary Parameters (Servo).....	39
4.7.3.1.7 Speed Loaded from Recipe.....	40
4.7.3.2 Pulse Roller Motor Settings.....	41
4.7.3.2.1 Set Conveyor Speed (Analog)	41
4.7.3.2.2 Set Auxiliary Parameters (Analog).....	41
4.3.4 Trend Alarm/Good Weight Settings	42
4.3.4.1 Reject Confirmation.....	42

4.3.4.2 Trend Alarm Condition.....	43
4.3.4.3 Goodweight Settings.....	43
4.3.4.4 Anyweight Settings	43
.....	44
4.4 Entering a Recipe – for a Checkweigher	45
4.4.1 Enter New Recipe.....	46
4.4.2 Select/Edit Old Recipe.....	46
4.4.3 Editing an Existing Recipe	48
4.5 Checkweigher Run Screen.....	49
4.6 Checkweigher I/O Map	50
Filler Controller Setup	51
5.1 Selecting Filler Type	52
5.2 Configuration settings for your filler.....	53
5.2.1 Set valve type	53
5.2.1.1 Combination Valve	53
5.2.1.2 Separate Valves.....	53
5.2.1.3 Special Combination Valve.....	53
5.2.1.4 Auger with Reverse	53
5.2.2 Set Settling Time	53
5.2.3 Set Blanking Time.....	54
5.2.4 Set Points Auto/Manual.....	54
5.2.5 Autotrack – ON/OFF.....	54
5.2.6 Start Delay.....	55
5.2.7 Auto TARE – ON/OFF.....	55
5.2.8 Display Flow Rates	56
5.2.9 Offset Compensation	56
5.3 Generic Filler	56
5.4 Gross Air/Impeller Filler	58
5.4.1 Gross Filler Traffic Control	59
5.4.2 Low Flow Broken Bag Detection	61
5.4.3 Recipe Entry	61
5.4.3.1 Refill Timer	63
5.4.3.2 Blast Air	63
5.4.3.3 Spout Purge.....	64
5.4.3.4 Chair Return	64

5.4.3.5 Broken Bag	64
5.4.3.6 After Fill Vibrate	64
5.4.4 Choosing Automatic or Manual Set Points.....	64
5.4.4.1 Automatic Set Point.....	65
5.4.4.2 Manual Set Point	65
5.5 Auger Filler	66
5.6 Net Weigh Filler	67
5.6.1 Bag Release Method.....	67
5.6.2 Dump Mode Options	68
5.6.2.1 Normal Dump Mode.....	68
5.6.2.2 Pass-Thru Dump Mode	68
5.6.2.3 Ultra Dump	68
5.6.2.4 Multi Dump by Count	68
5.6.2.5 Multi Dump by Weight	68
5.6.3 Net Weigh I/O and Sequencing	69
5.6.4 Net Weigh Recipe Entry	69
5.6.4.1 Net Weigh Target Weight.....	70
5.6.4.2 Hopper Discharge Time	71
5.6.4.3 Bag Clamp Release Time.....	71
5.6.4.4 Auto Track Response	71
5.6.5 Net Weigh Run Screen.....	72
5.7 Bulk Bag Filler Controls.....	73
5.7.1 Bulk Bag Inflate Time	73
5.7.2 Enable-Disable Filler Functions	74
5.7.2.1 Traversing Hooks Function	74
5.7.2.2 Latches Function.....	74
5.7.2.3 Cuff Function	74
5.7.2.4 Mid Fill 1 Densify Function	74
5.7.2.5 Mid Fill 2 Densify Function	74
5.7.2.6 After Fill Densify Function	75
5.7.2.7 Settling Method Function.....	75
5.7.3 Bulk Bag I/O and Sequencing	76
5.7.4 Bulk Bag Recipe Entry	77
5.8 Top Off Filler	79
5.8.1 Top Off Filler I/O and Sequencing	79

5.9 DWM IV Emulation Mode	80
5.9.1 DWM Mode Recipe	80
5.9.1.1 Discharge Time.....	80
5.9.1.2 Blanking Time.....	81
5.9.1.3 Settling Time	81
5.9.1.4 Fill Complete Time	81
5.9.1.5 Zero Lockout Time.....	81
5.10 Bulk Box Filler.....	82
5.10.1 Enable-Disable Filler Functions	82
5.10.1.1 Cuff Function.....	82
5.10.1.2 Mid Fill 1 Densify Function.....	82
5.10.1.3 Mid Fill 2 Densify Function.....	82
5.10.1.4 After Fill Densify Function	83
5.10.1.5 Settling Method Function	83
5.10.2 Bulk Bag I/O and Sequencing	84
5.11 Liquid Container Filler	86
5.11.1 Liquid Fill I/O and Sequence.....	86
5.12 Weightless Filler	87
5.12.1 Weightless Fill I/O and Sequence.....	88
Data Settings	89
6.1 Set Serial Port 1 Mode	90
6.1.1 Set Serial Port 1 Mode - Off	90
6.1.2 Set Serial Port 1 Mode to Ticket	90
6.1.3 Set Serial Port 1 Mode to Stream	92
6.1.4 Set Serial Port 1 Mode to Motor.....	92
6.1.5 Set Port 1 Baud Rate	92
6.1.6 Set Serial Port 1 Mode = Multi Remotes.....	92
6.1.7 Set Serial Port 1 Mode to Data On Demand	92
6.2 Set Ethernet Address	93
6.3 Product Load Options	93
6.3.1 SPPC-Lite Data Logging Software	94
6.4 Data Logger	94
6.5 Save/Restore Feature.....	94
6.6 Remote Recipe Load	94
6.7 Ethernet IP Option	97

6.5.1 EIP Interface – Process Data 97

6.5.2 EIP Interface - Recipes 99

6.5.3 EIP Interface – Tools Menu..... 102

6.5.4 EIP Interface – Calibration 106

Appendix A 109

Chapter 1

Important Installation Information

Thompson Scale Company offers a line of highly integrated scale controllers to cover many types of checkweighing and fill-by-weight applications. Two types of main processor boards are offered; one with an integrated 120VAC power supply, the other intended for connection of 24VDC directly.

1.1 Model 5511 Controller

The Model 5511 controller is equipped with the #815 processor board, containing a power supply rated for an input of 90 to 230VAC 50/60 Hz, with an output of 24VDC to power other components and I/O for this controller. The 5511 can be configured to operate one or two channels; dual checkweigher, duplex net weigh filler, 2-spout gross packer, etc., and includes an on-board Ethernet port and auxiliary RS-232 and RS-422 serial ports.

1.2 Model 6611 Controller

The 6611 controller is equipped with a #810 processor board, containing a connection for source 24VDC power. The 6611 is capable of operating up to four channels; 4-bucket net weigh scale, 4-lane checkweigher, etc. and includes many highly integrated features, such as automatic traffic control of bag discharge from a gross filling system. A resident Ethernet TCP/IP port and multiple serial ports are included.

Both the 5511 and 6611 have the same menus, calibration and general configuration. The majority of this user's manual will refer to the 5511 controller. These references apply to the 6611, except for source power connection.



WARNING: THIS EQUIPMENT IS TO BE INSTALLED AND SERVICED BY QUALIFIED SERVICE PERSONNEL ONLY

Instructions within this manual, and attached drawings, are to be strictly followed to insure both personnel safety and proper operation of the equipment. Please carefully read this chapter and chapter 2 regarding electrical installation and controller configuration before attempting to install or operate this equipment. Review specific settings and requirements for the type of scale or filling equipment being interface to the 5511 controller.

1.3 Electrical Requirements & Wiring Methods

1.3.1 AC Source Power Connection

The Model 5511 Scale Controller requires 90 to 230VAC source power from a dedicated branch circuit breaker rated at **15 Amps Max**. This breaker is to be used as the primary means of disconnecting power from the 5511 Scale Controller when performing maintenance. ***Please practice safety when working on or around the scale equipment.***

The 5511 controller does not typically require an isolation or power conditioning transformer. Power from 90 to 230 VAC, 50/60 Hz is acceptable. Minimum wire gauge for supply wiring is 16 Ga stranded conductor, provided with an Earth Ground. Solid conductors should not be used. All wiring routed to or from the 5511 controller must be provided in accordance with National Electrical Code requirements to maintain the NEMA 4X (IP66) rating of the control enclosure.

1.3.2 DC Source Power Connection

The Model 6611 Scale Controller accepts a source 24VDC, 5 Amp power connection point. A dedicated branch circuit breaker, rated at 10 Amps Maximum should be used. This breaker will be the primary means of disconnecting power from the 5511 Scale Controller when performing maintenance. ***Please practice safety when working on or around the scale equipment.***

1.3.3 Multiple Power Source Connections

If two or more sources of power, either AC or DC, or both, are used within the 5511 controller it is the user's responsibility to provide adequate warning at the controller of these multiple power sources and the location of their disconnect.

Recommended conduit sizes and wire sizes are noted on the controller layout drawing, found at the back of this manual. Voltage supply wiring must be routed per instructions found on the controller layout drawing found at the back of this manual.

1.4 Power Source Connection & Fusing

The bottom left corner of the #815 board contains a screw terminal block for connection of source AC power. A 14Ga stranded conductor is pre-wired from the Ground terminal to a ground lug on the back panel, and must remain in place. Ground from the source power connection should be added to either the screw terminal or to the ground lug provided on the back panel.

Two screw terminals for connection of Neutral are provided, as well as a connection for the source 120 VAC hot wire, connecting to Line IN.

The Line OUT terminal is protected by a **3AG 2** Amp Normal Blow fuse, and is typically used for connection to an auxiliary 120VAC Output Only board, #814 or #820 (sourcing 24VDC to 120VAC).

1.5 Input and Output Connections

The 5511/6611 Controller includes a #817 or #811 Scale-I/O Board that provides connection for inputs, outputs and load cell(s). The board includes eight (8) pre-assigned 24VDC Inputs and eight (8) pre-assigned 24VDC Outputs, each rated at 500ma. The #817 is a Sourcing I/O board, while the #811 is a Sinking I/O board.

Depending upon the type of equipment interface with the 5511, these I/O may read photo-eyes, switches, or interfaces from external system controls, and deliver outputs to operate valves, lights or external devices. Please refer to the chapter specific to the type of equipment being operated by the 5511 for more specifics on the I/O and sequence of operation.

1.5.1 Optional 120VAC Output Board

As an option, the #820 board can be added to the 5511 controller, connecting to the #817 board's outputs, to provide 120VAC outputs. The 820 board is supplied with a metallic mounting plate that installs vertically along the right side of the back panel, sharing the two right side screws that secure the back panel.

A cable runs from the #817 Scale-I/O board's 24VDC outputs to a set of terminals on the #820 board. A separate connection for source 120VAC power to the #820 must be made, per drawings found at the back of this manual or your system-specific drawings.



USE CAUTION WHEN CONNECTING AND USING THE 120VAC POWER TO THIS BOARD

1.6 Load Cell Connections

The #817 or #811 Scale-I/O board contains a terminal block for connection of a 4-wire or 6-wire load cell and shield. This board is compatible with 2mV/V and 3mV/V style load cells, and up to four (4) load cells can be connected via an approved summing board to the #817 or #811 board.

There are two sets of jumpers, one on either side of the terminal block for the load cell connection. The default position of the jumpers is on the "+5V" and "-5V" pins. This combined voltage provides 10VDC excitation voltage to the load cells.



USE EXTREME CAUTION IF DRIVING LOAD CELLS WITH MORE THAN 10VDC EXCITATION VOLTAGE. DAMAGE TO LOAD CELLS MAY OCCUR

Moving the jumper to the "+12V" and "-12V" pins will supply a 24VDC excitation voltage to the connected load cells. Over-driving load cells may damage the internal components of the load cell, so please consult the individual load cell manufacturer's specifications to see how the device may behave when over-driven.

1.7 Enclosure Mounting

The 5511 may be housed in a NEMA 4X (IP66) fiberglass enclosure with a hinged screw cover. The hinge pin and screws are 316SS. Molded fiberglass mounting tabs are provided with the enclosure, and are attached per the enclosure manufacturer's instructions to four (4) corner locations on the rear of the enclosure.

The 5511 is also available in an optional 304 and 316SS hinge-cover enclosure, and is also available as panel-mount and loose boards for installation within other devices or enclosures. PLEASE NOTE that proper wiring methods, described above, must be followed.

Another option available is a free-standing pedestal with wire entry through the bottom edge of the enclosure. This pedestal includes a back support plate for the 5511 enclosure. The vertical portion of the pedestal is constructed of sealed 3" square tube with a welded on flange for securing the back support plate and enclosure to the tube. The enclosure, back support plate and square tube are in turn bolted to a 18" square floor plate with pre-drilled holes to lag the plate to the floor.

Mount the enclosure to a stable and secure, vibration-free structure, such as a wall or beam, using proper hardware to ensure a secure mount. Place the enclosure with the centerline of the display approximately 52" from the floor.

1.8 Static Discharge Considerations



STATIC MAY DAMAGE EQUIPMENT OR INJURE PERSONNEL. EXTREME CAUTION SHOULD BE USED AND PROPER GROUNDING INSTALLED TO MINIMIZE OR ELIMINATE STATIC HAZARDS

The 5511 is designed for use with a wide variety of automated fill-by-weight and in-motion weighing systems. Product moving through pneumatic or gravity-fed supply lines, into and through storage bins, and through filling machinery will generate static. Moving conveyor belts and surrounding equipment to these conveyors may also generate substantial amounts of static. Find and eliminate all sources of static to ensure reliable and safe operation of this controller and your equipment.

1.9 Considerations for use in Hazardous Environments

The 5511 is equipped with a resilient polycarbonate overlay to protect the touch screen display. The display itself includes a ¼" thick shatter-resistant barrier between the touch panel and actual LCD glass. This can be interpreted as meeting the NFPA requirement for a non-breakable barrier between a hazardous environment and the interior of an enclosure.

Thompson Scale Company has designed the 5511 to be modified to accept intrinsic safety barriers to provide electrical protection for the display and additional safety barriers to protect load cell connections. In addition, other peripheral devices, such as properly rated and approved purge or pressurization systems, can be added to de-rate the interior of the 5511 from hazardous to non-hazardous.

The 5511 and 6611 controllers are NOT NFPA or UL Approved for use in Hazardous Environments

1.10 Condensation Considerations

Precautions should be taken to avoid condensation within the enclosure. Check-vents or low-pressure instrumentation purge lines can be added to help minimize the chance of condensation where humidity is high and rapid temperature changes take place.

1.11 Warning Statements



Automatic Start/Stop of Equipment may occur, based upon the program and program sequence chosen for the 5511.

The 5511 controller can be configured to operate filling equipment and provide automatic interfaces to robotic or conveying/filling peripheral equipment as part of the normal operation of this scale controller. **EXTREME** caution should be taken when working on or around equipment associated with the 5511 controller. Proper lock-out & tag-out procedures must be followed to insure safety.



When configured as a checkweigher, unintended and automatic actuation of an associated reject device may occur, if the scale is manually depressed.

The 5511 contains programming to operate as an in-motion checkweigher controller, monitoring weight crossing a moving conveyor, then actuating devices, such as reject devices, horns, alarms or lights. Use proper lock-out & tag-out procedures when working on peripheral equipment connected to or interfaced with the 5511 controller.



Sensitive Weighing Device Connections

Load cells connected to the 5511 are sensitive devices, and caution must be used when working around or with these devices.

DISCONNECT ALL LOAD CELL CONNECTIONS WHEN WELDING ON OR AROUND THIS EQUIPMENT.

1.12 5511 Components

1.12.1 Processor Board for 6611

The 810 board has a 24VDC source power connection and ability to hold 4 scale channels, plus an Ethernet IP converter board.

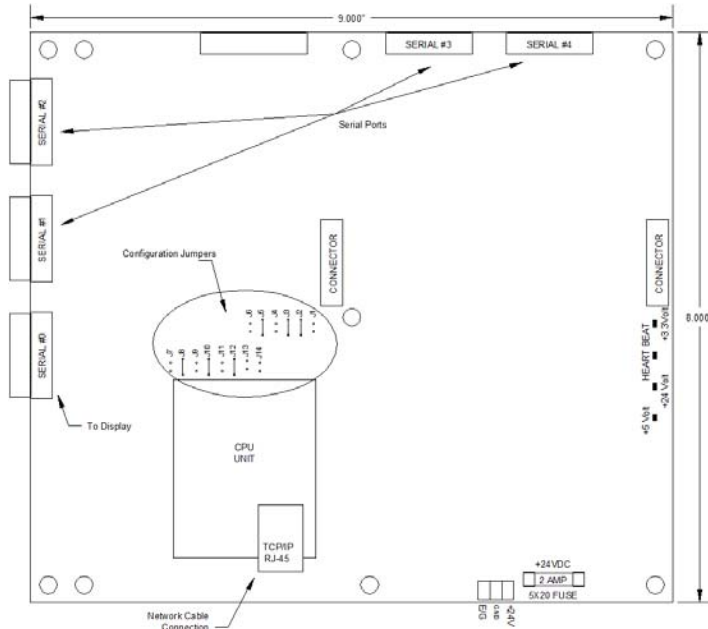

1.12.2 #815 CPU Board

This CPU board contains terminals for connection of 120VAC 2 Amp Source Power, a set of terminals that can be connected to an external switch for On/Off control, and fusing for 120VAC out to the optional #814 AC Output board. A 24VDC fuse is provided on the output of the switcher power supply. An Ethernet TCP/IP port is used for uploading program updates or changes.

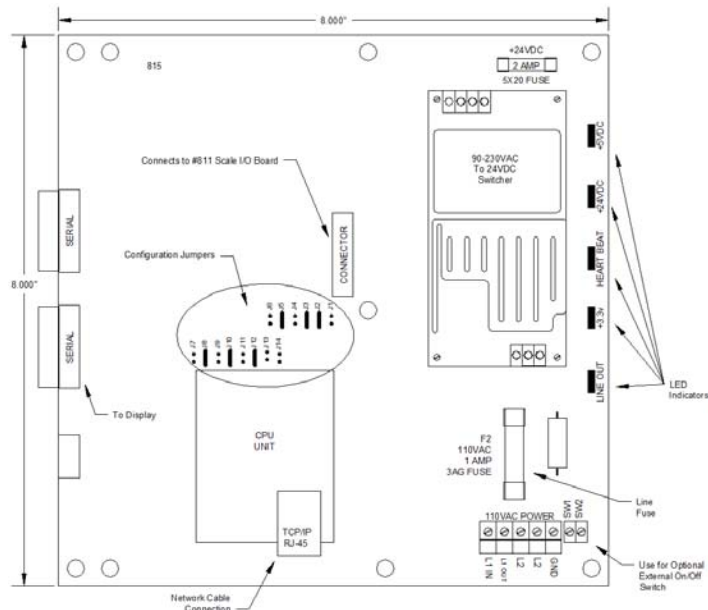

1.12.3 #817 & #811 Primary Scale & I/O Board

The #817 (sourcing) or #811 (sinking) board plugs into and mounts on top of the 811 or 815 board. One end of the board is for connection to up to four 350 Ohm load cells. The other end contains eight pre-assigned 24VDC Inputs, and eight pre-assigned 24VDC Outputs, which are optically isolated. Terminal blocks for wiring are removable to make wiring and board change out easier.

The 817 and 811 boards differ from the 819 and 812 boards, described below, being longer and containing a DC power supply needed to drive the scale circuit. Jumper settings, terminals 12, 10 and 9, are used for setting the address of this board. With no jumper this is Channel #1. With a jumper between 12 and 10 this board serves as Channel #3

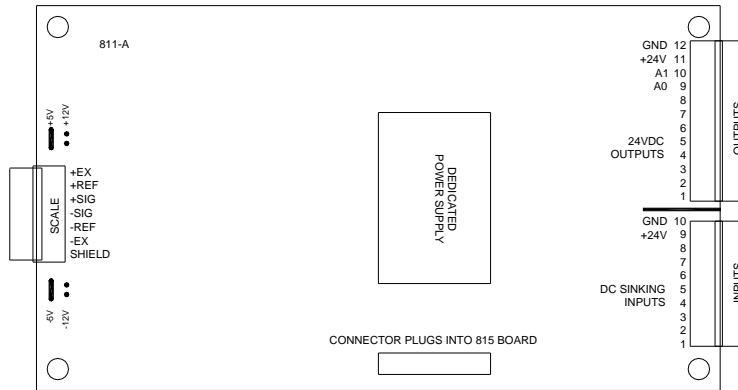

1.12.4 #819 & #812 Secondary Scale & I/O Board

The #819 (sourcing) and #812 (sinking) board plug into and mount on top of the #817 or #811 board. This board is used for dual and quad scale systems, playing the role of Channel #2, when jumpered from 12 to 9, or Channel #4 when jumpered from 12 to 9 and 10.

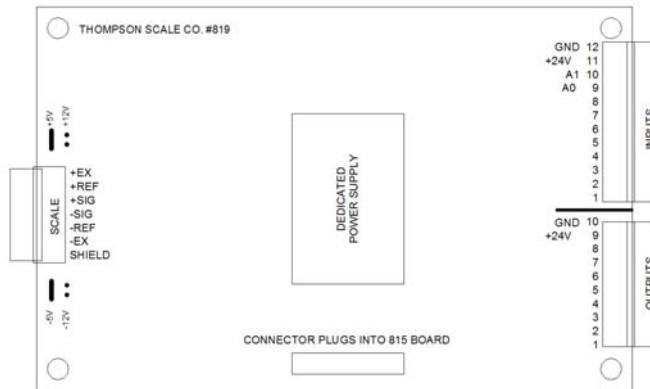

1.12.5 #820 & #814 Expander Output Board

The optional 820 (sourcing) or 814 (sinking) board provides 120VAC outputs for use with AC powered devices, such as lights, relays or solenoid valves. A cable runs from the Scale I/O board's 24VDC outputs and connects to this board's lower connector. The outputs are converted to 120VAC. An indicator LED is provided for each output to provide visual indication of the output being activated.

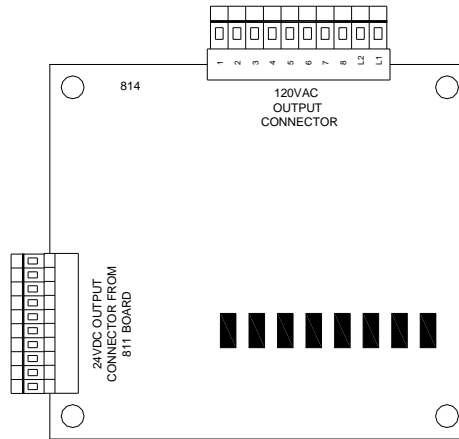

1.12.6 #813 Display Interface Board

Serial port 0 on the #815 CPU board connects to the #813 display interface board via a 6 conductor unshielded cable, connecting on each end at screw terminal blocks. The #815 serial port communicates to/from the display via RS-422. The 6-conductor cable can be run up to 30 feet from the #815 CPU board, allowing the user to place the display in a small remote enclosure and the main 5511 components in another location.

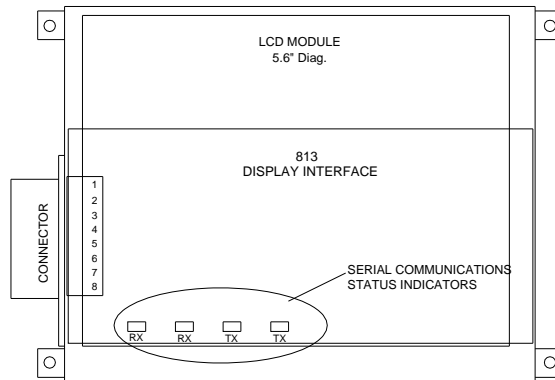

1.12.7 #816 Industrial Protocol Port

The 816-x board mounts on top of either the #817/#811 or the #819/#812 boards and is wired to communications port #2 on the #815 CPU board. Jumper setting J13 must be moved to J14 to enable Port #2 for this use. When used with the Model 6611 the 816 board connects to serial port #2 on the #810 CPU board. There is no jumper setting or change when used with the #810 board.

Protocols available with 5511/6611 program version 2.96 include:

Ethernet IP	#816A-AB6214
Profibus DP	#816A-6200
Modbus RTU	#816A-6203

Protocol must be defined at time of order.

The 816 board offers a RJ-45 network connection output port, providing weight data, recipe management and status bits for pass/fail and error routines.

The 816A-AB6214 EIP port can serve as a connection to a stand-alone #815 and #817 board set, with all instructions and interface to these boards, including calibration, handled through the user's PLC and HMI

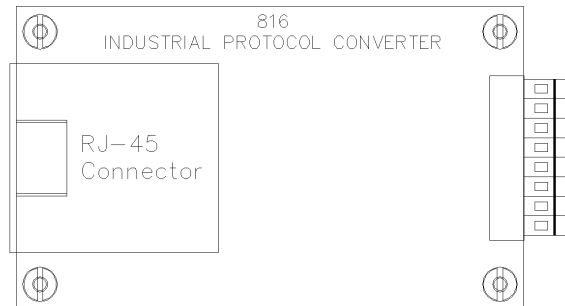

1.12.8 #821 Serial to Analog Dual Channel A-D Board

This board mounts within the 5511/6611 enclosure, using serial Port #2 to provide digital weight data for Channels #1 and #2 through the same serial port.

Chapter 2

5511 & 6611 General Configuration



WARNING: CHANGES TO CONFIGURATION WILL AFFECT PERFORMANCE AND OPERATION OF THE SCALE CONTROLLER, AND MAY YIELD UNDESIRE RESULTS. READ AND UNDERSTAND SETTINGS BEFORE MAKING CHANGES

Changes made to configuration settings, such as sample rates, filter frequencies and decimal place will have a direct effect on reading and responding to weight, and therefore will affect behavior or performance of I/O devices connected to this controller.

2.1 Creating password protection

The setup and recipe functions should be protected with a password. To enter a password, touch the “MODEL 5511” or “MODEL 6611” logo at the top of the main screen.

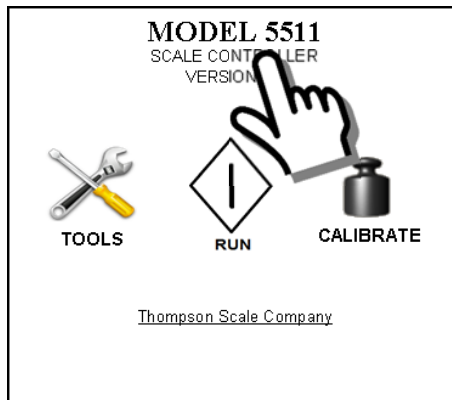

A new screen will appear:

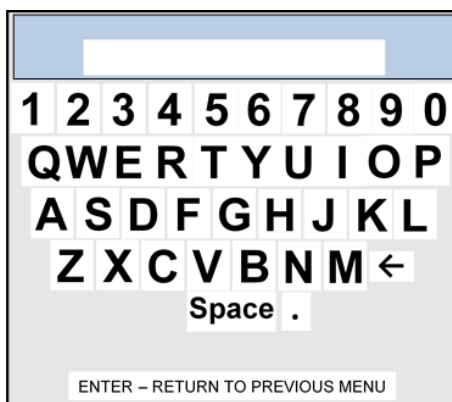

Type the word “scale”, then press the “Enter” key

Select the level of password to apply:

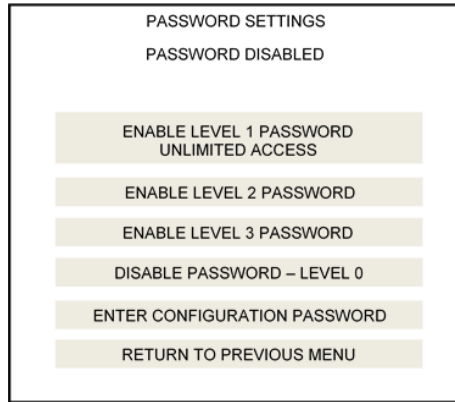

Level 1 password is the Administrative password and provides rights to enter all screens and adjust or calibrate any feature of the 5511 controller.

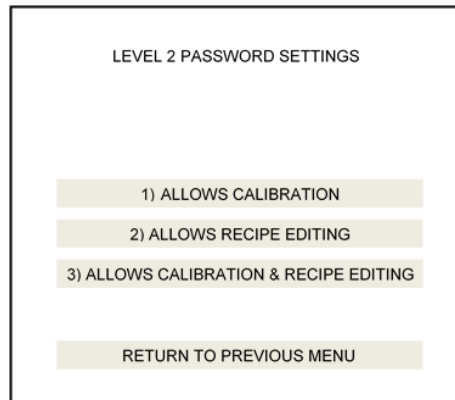

Level 2 password is for supervisory personnel, and the administrator can allow some limitations to access

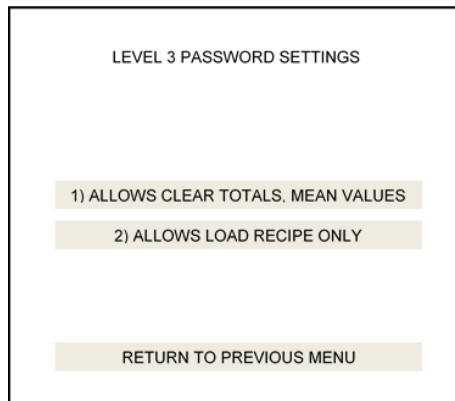

Level 3 password is typically for operators, and restricts their actions to simply loading a recipe from the main "Run" screen, or this *and* the ability to clear statistics during a run.

2.2 Controller Configuration for Equipment Type

The 5511/6611 has been designed to be configured for a variety of specific types of automated filling and weighing equipment. Changing configurations changes many of the screens, the I/O and sequencing to be unique to a particular equipment type.

With the power disconnected, remove the screws holding the Scale & I/O board to the #810 or #815 CPU board. Typically there are 4 screws holding a secondary scale & I/O board (#812 or #819) and 5 screws holding the primary scale & I/O board (#811 & #817). A ribbon cable connects the secondary to the primary, and the primary to the #815 CPU board.

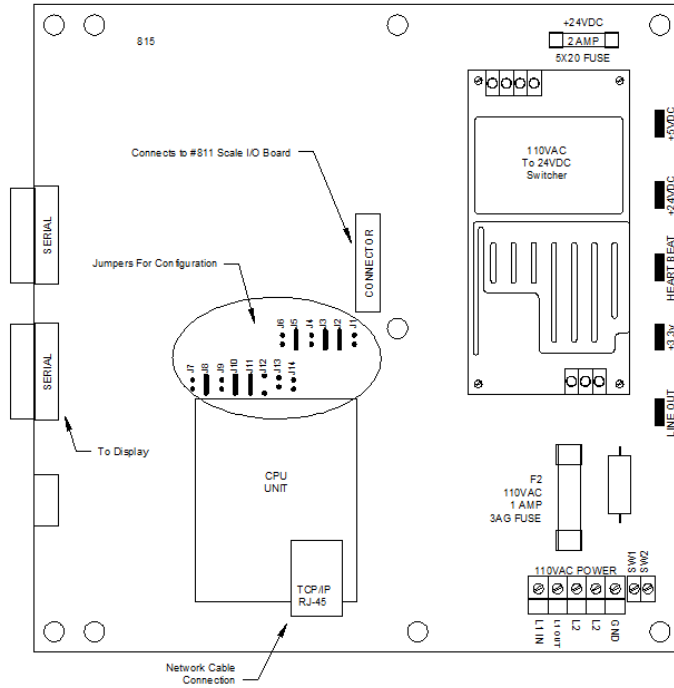

To use the 5511/6611 as a checkweigher, place jumpers as shown in this table.

Function	Jumper	Setting	Default
Serial Port 0 – For Display	J1	RS-232	
	J2	RS-422	Set
Serial Port 1 – Comm Channel	J3	RS-232	
	J4	RS422	Set
Serial Port 2 – Comm Channel	J5	RS-232	
	J6	RS-422	Set
LCD Touch Screen Type	J7	Not Used	
	J8	EZ LCD	Set
Equipment Type	J9	Checkweigher	Set
	J10	Filler	
Program Mode	J11	Locked	Set
	J12	Configure	
5511 Serial Port 2	J13	Serial	Set
	J14	Industrial Protocol	

To use the 5511/6611 as a filler controller do the following:

1. Power down the controller
2. Move jumper J9 to J10 (set to equipment type of filler)
3. Move jumper J11 to J12 (set to program selection mode)
4. Power up the controller

Chapter 5 describes the filler types and their configuration

Once configuration of the filler type is complete, power down the controller and move J12 back to J11. This places the controller back in the "locked" mode. If you forget this step the controller will display and error message to move the jumper.

2.3 General Configuration Settings

Press the main screen "Tools" icon to access system configuration and setup.

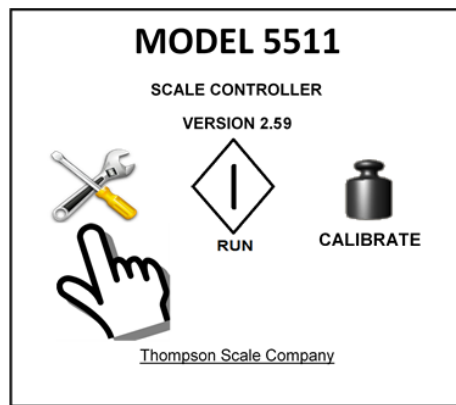

The configuration menu will appear:

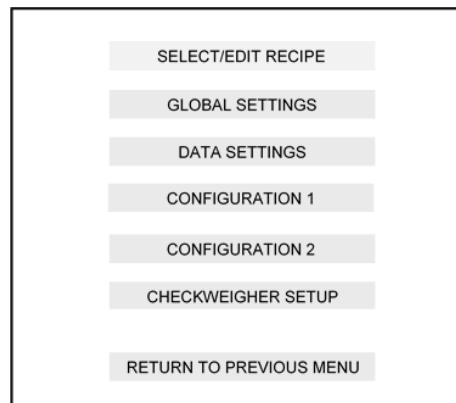

This chapter will cover basic scale configurations; Configuration 1 and Configuration 2. Other configuration items, including Recipe entry/edit, global settings, data settings and either checkweigher or filler setup are covered under separate chapters for Checkweigher, Gross Filler, Net Filler, etc., as the controller is configured by the user.

2.3.1 Configuration 1 Settings

Press the Configuration 1 button, and the following screen appears:

SET A-D SAMPLE RATE	24
SET FILTER FREQUENCY	5
SET NUMBER OF FILTER SAMPLES	8
SET DECIMAL PLACE	2
SET A-D GAIN	
SET NUMBER OF WEIGHT CHANNELS	1
SET MAX NUMBER OF RECIPES	2
RETURN TO PREVIOUS MENU	

2.3.1.1 Set A-D Sample Rate

The A-D sample rate is the conversion rate of analog samples taken from the load cell or scale and converted to a digital value. The samples are then delivered from the A-D converter, found on the 811, 812, 817 or 819 Scale I/O board, to the system's CPU for further processing and use in making decisions about weight.

This value is adjustable from 20 to 200, with all samples used by the CPU to calculate weight and display weight data on-screen. A typical valve bag filler or net weigh scale runs at a sample rate of about 60 to 100 samples per second. An in-motion scale with throughput rates up to about 40 packages per minute can run at a sample rate of around 25. High production rate checkweighers, running at rates in excess of 350 packages per minute require a sample rate near 200/second.

Too low a sample rate and not enough information is gathered to capture the peak or plateau of weight samples required to determine proper weight. Too high a sample rate may lead to erratic or "jumpy" weight values



WARNING: Default Sample Rate for Fillers is 100/second. When the 6611 is configured as a 4-channel controller this value is reduced to 75/second. Increasing the sample rate on a 4-channel controller may cause controller errors. Cycling power on the controller will automatically reset sample rate to 75/second

2.3.1.2 Set Filter Frequency

The 5511 controller contains a 5-8pole low pass filter that offers an adjustable frequency from 2 to 30 Hz. The factory default setting is 5. Mechanically "noisy" applications may require a lower value to clamp down on errant vibration or interference, with a sacrifice of response time. Very fast weighing applications, such as checkweighers running in excess of 100 packages per minute, will require a higher value to allow very short-duration peak values to attain desired weight, with a sacrifice in noise immunity.

2.3.1.3 Set number of filter samples

The filter samples setting refers to the number of samples averaged to obtain the next weight reading. The filter is a sliding-average filter, where a set group of weight values are received from the scale and updated based upon the Sample Rate.

As a new weight sample is received, the oldest in the array is discarded. A new average value is then calculated from the updated array of weights. This has a filtering and balancing affect, and is very useful for in-motion and fill-by-weight applications. The value can be adjusted from 8 to 32.

Increasing the value to higher than the default of 8 will require a longer period of time to average since more samples are required. Increasing the Sample Rate at the same time will diminish the time required to acquire the number of samples, in turn reducing the time required to calculate the new average.

If the filter sample value is increased to say 16 or higher, and the factor default Sample Rate of 24 is left in place the scale may have difficulty detecting fill weight increases or package transitions quickly enough to properly respond to the application needs.

2.3.1.4 Set decimal place

The default setting is 02. This value can be changed from 0 to 3, depending upon the full load capacity of the scale and the package or part being weighed. Typically this value is set to allow for 10,000 divisions of the load receiving device. A scale weighing a 5 lb. part and using a 25 lb. scale may select 3 decimal places and meet the division requirement. However, a 1,000 lb. part weighed on a 10,000 lb. scale should have a decimal place of 0.

2.3.1.5 Set A-D gain

This value is internally calculated as part of the calibration routine. It is not normally an adjustable value and has a factory default of 200 counts. Minimum value is 0, maximum value is 255. A typical Gross packer, Net Weigh Scale or Checkweigher have offset deadload that equals to about ½ of this value range.

2.3.1.6 Set number of weight channels

The 5511 is capable of operating two separate scales simultaneously and independently. TSC's Model 6611 is capable of operating for separate scales from one controller.

2.3.1.7 Set max number of recipes

The 5511 has a capacity of 100 product recipes. Each recipe contains Target weight for fill or checkweigh, and parameters associated with that process.

Over time many of these recipe locations may become invalid or filled with invalid information. Using this configuration setting it is possible to reduce the number of active recipes, effectively deleting groups of recipes. For example, if there are 45 recipes in memory, but only 10 are actually valid, then setting this value to ONE MORE THAN REQUIRED, or to a value of 11, will delete recipes 11 through 45 from memory, allocating memory for a new recipe in position 11.

To eliminate all recipes, except the first recipe, set this value to 2.

2.3.2 Configuration 2 Settings

Press the Configuration 2 button, and the following screen appears:

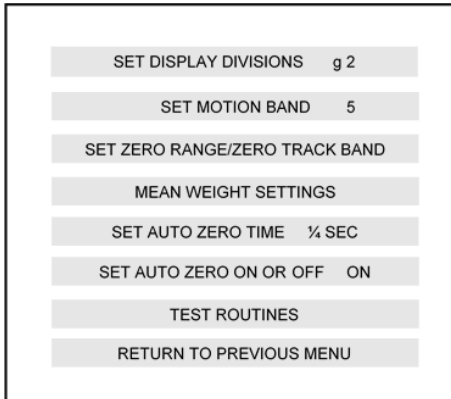

2.3.2.1 Set display divisions

Display divisions can be set to a value of 1, 2 or 5 as the least significant bit in the displayed weight value.

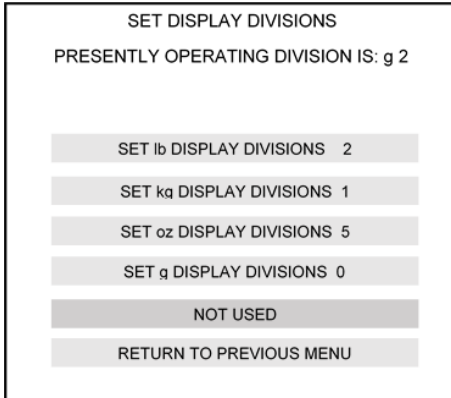

Entering into this menu will display division settings for lb, kg, oz & g. Pressing on the appropriate block will toggle the value to the next increment.

2.3.2.2 Set motion band

The motion band represents the amount of variance of the least significant digit that can be seen in consecutive scale readings and still be considered within an acceptable range for automatic zeroing of the scale. Some applications may be subject to more vibration than others, and may not be capable of capturing the necessary consecutive samples required to perform a zero. The following screen is displayed.

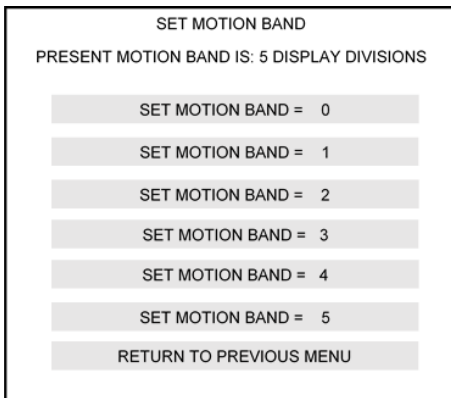

2.3.2.3 Set zero range

The zero range setting is a routine central to maintaining the accuracy and long-term performance of a filler or checkweigher. Product spillage and temperature variation will affect the scale, if the controller does not perform regular updates to the system's operating zero.



This routine can automatically zero any deviation from the current operating zero, up to 2%, 5%, 10%, or unlimited % of the test weight size. See Calibration Chapter 3 for information on selecting the proper test weight for your scale. Each time the zero is updated, an "AZ" symbol appears on the Run screen, just to the right of the weight display.

A system zero is established during calibration, and is the reference for all future auto zeroing of the scale. Programming within the controller constantly monitors the output of the scale's load cell, and compares these readings to see if the scale is involved in filling or weighing a package.

These readings are also compared to the system zero. If the readings are unchanging, within a narrow band, AND remain within this range for a set period of time, the operating zero is updated.

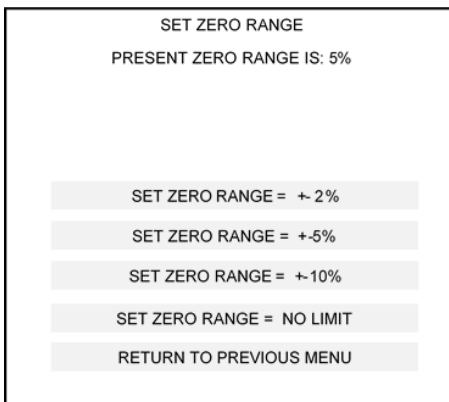

If the new zero is greater than, say 2% of value established during calibration, the 5511 will zero 50% of the difference, and then search for a new zero using the same range and time constants to compare for a steady scale reading. This process will continue until the difference between the current and new zero are within the 2% range, then 100% of the value is corrected. This basically filters large changes being made in the scale. For example, a test weight of 50 lbs. used for a heavy-duty checkweigh scale has an auto-zero max value of 1 lb. If a broken bag spills 2 lbs of product on the conveyor, the next auto-zero opportunity will allow the scale to zero out 50% or 1 lb. The next auto-zero opportunity will zero out the remaining spillage.

2.3.2.4 Set zero track band

This variable sets the amount of variance that can be seen in consecutive scale readings and still be considered within an acceptable range for auto zeroing. Some applications may be subject to more vibration than others, and may not be capable of capturing the necessary consecutive samples required to update the zero. Opening up this band from the default of 2 display divisions to 3 or 4 may allow the scale to properly maintain zero and still not sacrifice stability of the scale.

SET ZERO TRACK BAND

PRESENT ZERO TRACK BAND IS:5 DISPLAY DIVISIONS

SET ZERO TRACK BAND = 1

SET ZERO TRACK BAND = 2

SET ZERO TRACK BAND = 3

SET ZERO TRACK BAND = 4

SET ZERO TRACK BAND = 5

RETURN TO PREVIOUS MENU

2.3.2.5 Average Weight Setting

This feature is for use with the in-motion and static checkweigh function of the 5511 controller. It does not apply to the manifest, dual-target checkweigher or filler configurations.

When this menu is selected the following screen will appear:

SET NUMBER OF SAMPLES FOR
MEAN UNIT WEIGHT

NUMBER OF SAMPLES TO AVERAGE = ALL

CLEAR AVERAGE UNIT WEIGHT

INCLUDE REJECTS IN AVERAGE

NOT USED

NOT USED

RETURN TO PREVIOUS MENU

2.3.2.5.1 Number of samples to average

Within this screen the user is presented with the option of choosing the number of weighments to average for display on the run screen. This value is shown just below the zone total boxes, between Total Units and Total Weight.

The value can be set from 2 to 100, or to 255. Setting the value to 20 will cause the checkweigher to accumulate 20 weighments then average and display. This value remains unchanged until the next 20 weighments are complete, then the value will update. Setting the value to 255 will result in the average of all accumulated weighments for the production run, with the average updated as each weighment occurs.

2.3.2.5.2 Include rejects in average

This setting gives the user the option to average only acceptable weighments or to include all weighments, both good and rejected.

2.3.2.6 Set auto zero time

The auto zero time setting allows the user to adjust the amount of time required to monitor the scale's motion band. A setting of 0 second will cause a new zero to be taken the moment the scale's output meets the criteria for range and motion band. Setting this value to ½ second will cause the controller to seek acceptable readings within the motion band for ½ second before updating zero. This provides another form of filtering exactly how and when a zero update is made.

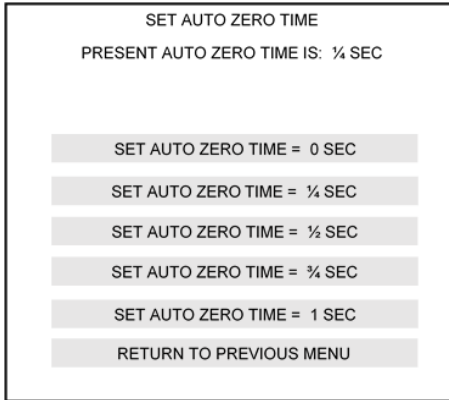

2.3.2.7 Set auto zero on or off

An option is presented to disable the entire auto zero function. Select this button to toggle the function on or off. Now that the controller's basic configuration has been completed, select the next section that relates to the filler or checkweigher selected via hardware jumper.

2.3.3 Test Routines

The 5511/6611 controller contains several different tests to verify internal communications and operate the checkweigher in a simulated mode:

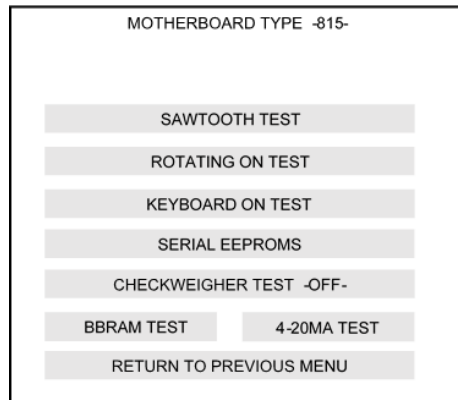

The Sawtooth test is conducted at Thompson Scale Company and requires connection of an oscilloscope. We use this as one of our final tests prior to releasing a new 5511/6611 for shipment. It is not intended for field use.

2.3.3.1 Rotating On Test

The rotating On test turns on each output, starting with output #1, for one (1) second, then turns that output off, turning on the next output. This sequence continues until the user exits from the screen. Displayed on-screen are each of the 5511's eight inputs. A "0" is displayed below each input number. When the input is actuated; button pressed, photo-eye blocked, etc., the corresponding "0" changes to "1", indicating that the controller recognizes that the input is actuated.

If the input is actuated, but the "0" doesn't change to "1", look to the corresponding LED associated with that input on the Scale & I/O Board for that weight channel.

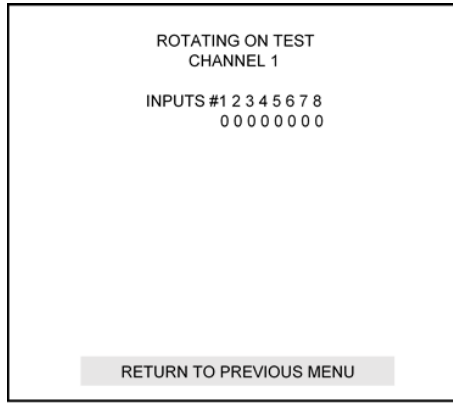

2.3.3.2 Keyboard On Test

The keyboard On test presents a screen with a large key for each output. Press the key once, and the corresponding output turns on and stays on until you either press the key again or press “return to previous menu”. The row of inputs are displayed for test/verification, as described in the rotating on test procedure, above. This is an excellent test for tracing wires and verifying actuation of motors, solenoid valves, etc.



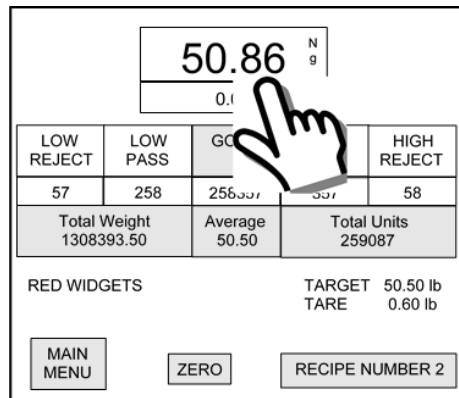

2.3.3.3 Live I/O Status Screen

A simple method for viewing status of each I/O point for each channel is provided through the “Run” screen. This status view is the same for a checkweigher or filler controller configuration. While in the “Run” screen, touch the main weight value:



The bottom of the screen will change, displaying the channel number, inputs and outputs, as shown on the next page:

<table border="1"> <tr> <td style="text-align: center;">50.86</td> <td style="text-align: center; vertical-align: middle;">N g</td> </tr> <tr> <td colspan="2" style="text-align: center;">0.00</td> </tr> </table>					50.86	N g	0.00	
50.86	N g							
0.00								
LOW REJECT	LOW PASS	GOOD	HIGH PASS	HIGH REJECT				
57	258	258357	357	58				
Total Weight 1308393.50		Average 50.50	Total Units 259087					
CHANNEL #1 INDICATORS								
OUTPUTS			INPUTS					
								
1 2 3 4 5 6 7 8			1 2 3 4 5 6 7 8					

As each input is actuated; switch, photo-eye, sensor, etc. the corresponding input number will change from a white background to green. As outputs are turned on, the corresponding output number will change from white background to green. There may be more than one input and/or output on at one time.

2.3.3.4 Read Serial EEPROM

The serial EEPROM stores calibration information as well as other important variables created during configuration. Reviewing this information provides particular insight into the inner workings of calibration for the scale and indicator. The following screen is displayed:

lb CALIBRATION FACTOR IS	6F17
kg CALIBRATION FACTOR IS	3262
oz CALIBRATION FACTOR IS	FFFFFFF
g CALIBRATION FACTOR IS	5894
NUMBER OF RECORDS IS	2
EVENT COUNTER IS	2
CODES 1, 2 ARE	55 AA
RETURN TO PREVIOUS MENU	

2.3.3.5 Calibration Factors

This value is determined during calibration, and defines the relationship between the capacity of the scale and the signal differential between an empty scale and a scale with test weight applied. This value will differ between calibrations in different units; lb, kg, oz, g. If the 5511 is not calibrated in one of these units the value displayed will be FFFFF (hexadecimal for “blank”) It is not necessary to calibrate the scale in units other than those typically used with the equipment.

2.3.3.6 Checkweigher Test

Activating this test will cause the checkweigher to function as though product is crossing the scale. Weight values are displayed, zone boxes turned on, outputs are actuated for zone lights and reject outputs, and data is transmitted from all ports.

This mode is an excellent way to conduct troubleshooting of the “active” checkweigher and its data, even if the production line is stopped or the scale isn’t yet installed.

Once this selection is made, you must leave the “Tools” menu screens and go into the “Run” screen.

2.3.3.7 BBRAM Test

This type of memory, used at TSC during diagnostics when repairing the processor board.

2.3.3.8 4-20mA Test

Thompson Scale offers a #821 Dual Channel Analog output card. This card is only compatible with the Model 6611 controller, using Port #3 on the #810 CPU Board.

Selecting this test presents a screen for checking output of the #821 at different levels:

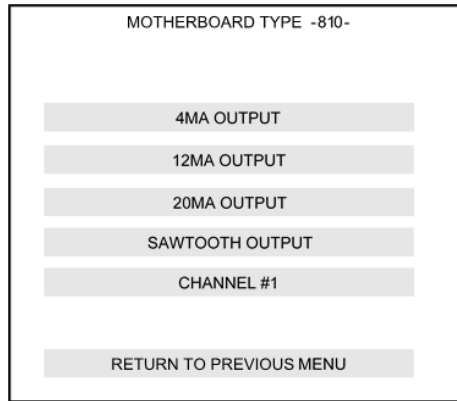

At rest, and with no fill or weigh program actively driving the #821 card, it will have an output of 0mA.

Touching each of the 4mA, 12mA and 20mA buttons will drive both channels of the #821 card to that output for your verification with an external device; meter, PLC port, etc.

The Sawtooth output ramps the signal from 0 to maximum one time every second. Please refer to the separate instruction set for the #821 Analog board for details on use and calibration of this board.

Chapter 3

Calibration

The 5511 requires a single static calibration for operation of a fill-by-weight or in-motion checkweigher system. Calibration is done with the equipment completely assembled; conveyors in place on top of scales, net weigh scales, suspended, etc.

The calibration routines require a test weight large enough to generate a 2-1/2 to 3 mV change in the scale output. It may be advisable to take a reading of the scale with only the deadload (conveyors, etc.) in place, then apply a known weight and measure the difference. Adjust the amount of test weight to reach the 2-1/2 to 3mV offset required. Dynamic calibrations are not required and no accommodations are made within programming of the 5511 to manage these types of calibrations. Errors seen in weight during filling or weighing may indicate improper settings for sample rate, filter frequency and/or settling time. Please review these settings and adjust as required.

3.1 Calibration Screen

From the Main Menu, select the test weight icon:

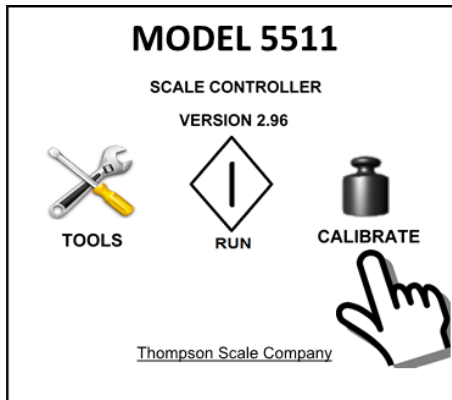

A series of screens prompt the operator through the calibration process, with the first screen offering time/date confirmation and settings to correct:

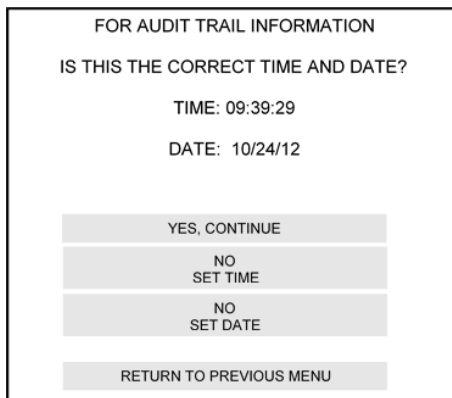

If "Yes, Continue" is selected, the following screen appears:

If "No" is selected, a keyboard is presented for entry of this information. It is stored and later used to create a detailed audit trail of when calibration was executed, by whom, and what the calibration values were. This can be accessed through the "Tools" menu.

The next screen presented requires the user's I.D. or name for use in the audit trail:

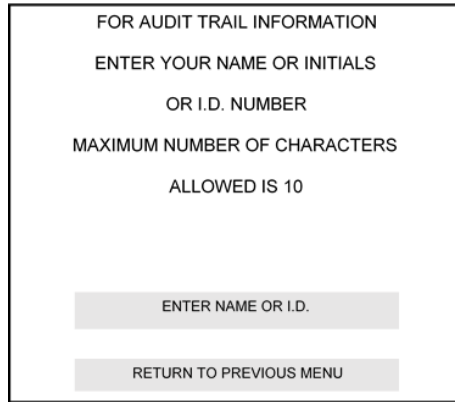

FOR AUDIT TRAIL INFORMATION
ENTER YOUR NAME OR INITIALS
OR I.D. NUMBER
MAXIMUM NUMBER OF CHARACTERS
ALLOWED IS 10

ENTER NAME OR I.D.

RETURN TO PREVIOUS MENU

The next screen verifies the test weight used to calibrate:

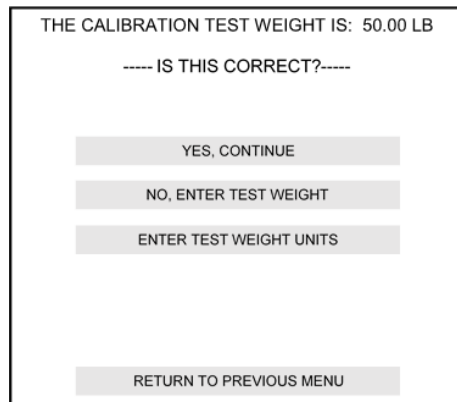

THE CALIBRATION TEST WEIGHT IS: 50.00 LB
----- IS THIS CORRECT?-----

YES, CONTINUE

NO, ENTER TEST WEIGHT

ENTER TEST WEIGHT UNITS

RETURN TO PREVIOUS MENU

If the test weight value is incorrect, select "No, Enter Test Weight", and a screen will appear for entry of this value. A button is also available for changing the calibration weight units.

The 5511 can be calibrated in pounds (lb) and can convert to kilograms (kg), but cannot convert to ounces (oz) or grams (g). Calibration in either of these other units is required separately, if needed.

Selecting "Yes, Continue" will present the following screen:

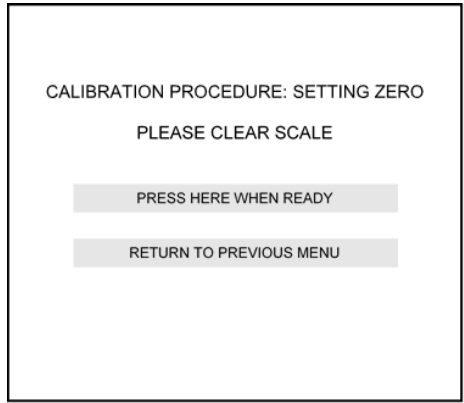

This screen prompts the user to clear the conveyor or filler, then press the Green “Press Here When Ready” button to proceed. The 5511 will run an internal potentiometer to adjust to match the scale output and establish a Zero operating point. A screen will display progress of this zero setting, showing a DAC number and Offset number:



The DAC Number represents the actual Digital to Analog Conversion being executed within the 5511 controller. This value will vary from 0 to 1024 counts, and is typically in the 2 digit range. A value falling close to 0 or increasing upwards of 1024 indicates that the controller is having difficulty adjusting for the scale and deadload.

The Offset Number refers to a pure numeric equivalent of the 5511’s analog conversion. This value is within range anywhere from -100 to +100, and is typically in the single or 2-digit range.

If either of these values adjust out of range it may indicate an issue with the load cell(s) or wiring issues between the scale and the 5511 controller’s 811 or 817 Scale input.

Press the “Press Here to Continue” button, and the screen will advance to:



The next screen shows that Span is being set, then, advances to the Calibration Complete screen:

```

-----CALIBRATION OKAY-----
WRITE TO SERIAL EEPROM OK

CALIBRATION READING IS:           12489
OFFSET NUMBER IS:                 4
#1 LB CALIBRATION FACTOR IS:      0000676D
#1 GAIN SETTING IS:              182

      AUDIT TRAIL RECORD
NUMBER  TIME  DATE  CAL-FAC  OPERATOR
022    09:39:24  8/22/14  000676D...RJ1229

REMOVE TEST WEIGHT BEFORE PRECEDING

RETURN TO PREVIOUS MENU

```

The calibration completion screen provides information on the final settings for calibration, including the final A-D Calibration reading, the offset value, as displayed in the previous screen, and a Calibration Factor. This value is derived internally and is a reference used as part of the audit trail. If the scale remains unchanged and the test weight value is the same, this factor, and the gain setting, should remain consistent.

The gain setting is the amount of amplification required to drive the scale and attain proper calibration. The optimum number is 200. Lower numbers, down to 90 or so, are acceptable, while numbers over about 230 may yield a "jittery" or unstable scale reading since the gain is so high. Use a slightly larger calibration weight to reduce the gain value.

3.2 Calibration Errors

Several calibration error warnings may be displayed:

Cannot Zero Scale is typically encountered when the load cell output is at either zero millivolts (mV) or below, or is greater than 30 millivolts. Check the load cell mount for mechanical restrictions such as improperly adjusted shipping bolts within the scale, or mechanical binds caused by interference between the spout or bag post and the surrounding structure.

No Test Weight on Scale is displayed if the millivolt output of the load cell when the test weight is applied is either no different than or only slightly different than the reading without the test weight applied. This usually indicates that either the test weight is too small, the load cell is damaged, or shipping links have not been removed from the scale. There should be a minimum of a 2.5mV change in the load cell output from no test weight on the filler and the load cell applied. A larger test weight may be used, which should equal at least 10% of the full load capacity of the load cell.

Span at Either Min or Max indicates that the digital potentiometer used to adjust Span is either adjusted to its minimum or maximum value, and that the Span of the load cell cannot be captured. This typically indicates one of two problems. The first is that the size of test weight used in proportion to the load cell full load capacity is not adequate to induce the minimum required offset between the zero established in the first part of calibration and the current load cell reading. The controller requires a minimum of 2.5 mV offset between the zero reading and the test weight applied reading. Use of a larger test weight typically remedies the problem. The second possibility is that either the Scale-I/O Board or the load cell are damaged and should be tested and/or replaced.

Chapter 4

Checkweigher Configuration

When the 5511 is configured to operate as a checkweigher, it must be first configured to have the characteristics desired; I/O configurations, and display, and then recipes and settings for reject timers and alarms must be configured.

This chapter first covers the configuration, then details recipe entry and settings for timers.

From the 5511 main screen, select Tools, then select Checkweigher Setup:

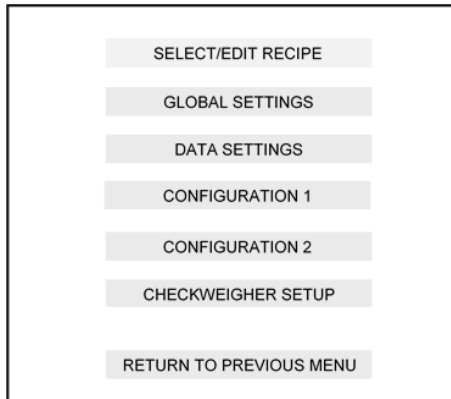

When “Checkweigher Setup” is selected, the following screen appears:

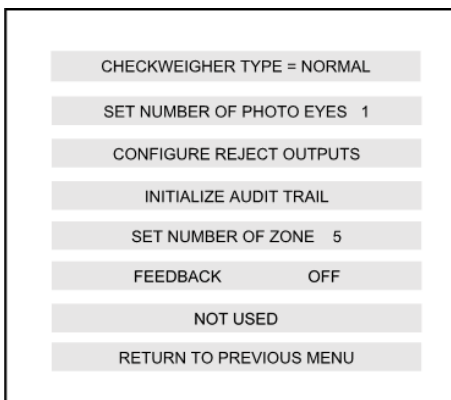

4.1. Checkweigher type

The 5511 offers two basic types of checkweighers; Normal and Manifest.

4.1.1 Normal Mode Checkweigher

Refers to a program for in-motion weighing with a fixed target weight, TARE weight and upper and lower reject limits. Packaging is run in lots or campaigns of the same package size and weight, such as bags of cement or loaves of bread, for extended number of packages or over a span of time. Each package crossing the scale is compared to the target and limits, and corresponding visual indicators and outputs are generated in response to the weight value. If this configuration of scale is selected, also select the number of zones; either 3 or 5.

4.1.2 Manifest Mode Checkweigher

A manifest system references a scale used to weigh random packages, calculating and displaying the weight value, and providing visual and data output of the weight data. Airports weigh luggage or cargo into planes, order fulfillment warehouses ship a tube of lipstick or a book, with no two packages corresponding to a common target weight. This type of checkweigher does not have corresponding outputs, other than an alarm for loss of calibration or a production error or event.

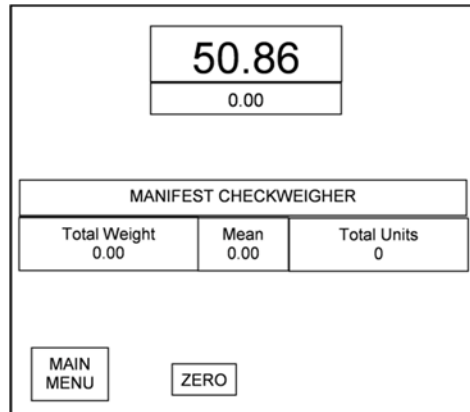

4.1.3 Static Mode Checkweigher

This style checkweigher is intended for manually placing a package or part onto a fixed scale platform and verifying the weight value. For example a tray filled with food or a bag filled with screws can be placed on the scale and product added until the weight value and corresponding colored "good" weight zone are displayed. An input from a pushbutton or foot switch completes the current weighment and transmits the weight value from the Ethernet TCP/IP and serial ports.

4.1.4 Dual Target Mode Checkweigher

This style checkweigher is for in-motion weighing and for applications where two distinctly different package weights are being run simultaneously on the same production line. For example; producing a 3 lb. bag of onions and simultaneously running a 5 lb. bag of onions, merging both up-stream of the checkweigher.

The user sets up recipes for these different products so that recipe #1 and #2 are run concurrently on the checkweigher. The program structure will always compare the consecutive odd and even recipes; 1 & 2, 3 & 4, etc.

Caution should be used to ensure there isn't any cross-over of a good weight value for one recipe being interpreted as a reject weight value for the other recipe. That is, for the 3 lb. bag the upper reject limit will most likely be 3.5 lbs. or so. The 5 lb. bag will not have a low reject limit at or below 3.5 lbs. Both target weights are displayed on the run screen.

4.2 Set number of photo-eyes

The 5511 checkweigher algorithm used for detecting and weighing packages crossing a conveyor is one of the most advanced and reliable around. In many circumstances there is no need for an in-feed or exit end photo-eye to initiate or terminate a weighment cycle on a package, with the 5511 monitoring the scale's output and determining when a package enters and begins leaving the conveyor.

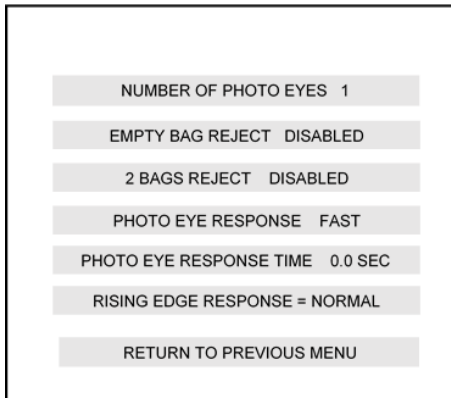

However, this doesn't always fit every application, and some require either a weight terminating photo-eye at the exit of the conveyor, or a combination of an entry photo-eye and exit photo-eye to properly weigh packages. This configuration step offers several options for enabling or disabling photo-eyes and also contains settings for response time and performance of these eyes and the scale:

4.2.1 Number of Photo Eyes

As described above, many times the 5511 checkweigher program will not require photo-eyes. The checkweigher monitors the output of the scale at the sample rate and filter frequency set in the 1st configuration screen. An operational zero is maintained, based upon settings for that feature.

As a package begins to enter the scale conveyor, the output of the scale increases. When the checkweigher program recognizes a specific number of upward trending weight samples, this starts the weighing process. The package now completely enters the scale conveyor, and weight output from the scale plateaus or stabilizes at this higher output. The leading edge of the package reaches the end of the scale conveyor and begins to exit. Weight output begins to rapidly decrease as this happens.

Once a specific number of downward trending weight samples are detected the checkweigher program recognizes that the package is leaving and terminates taking weight samples. The plateau is averaged, compared to the Target and reject limits, if any, and generates a weight and display.

This sets the pitch of the package to the length of the scale conveyor + the distance required for the package to exit and terminate the weighing process. A 50 lb bag or box normally requires about 3" of the leading edge to exit the conveyor. Smaller and/or lighter packages may trigger earlier or later, depending upon a number of other factors.

Using this method works well with packages that generate a 4 or 5 mV increase from the empty conveyor's normal mV reading. Applications running heavy and light packages may find that the scale does not properly trigger on the light packages because the profile of that package is small enough it may not meet criteria to initiate or terminate a weighment cycle. Adjusting the number of filter samples may improve performance on light weight packages. See Configuration Menu #1 "Set Number of Filter Samples"

4.2.1.1 One Photo Eye

Placing a photo-eye (Sinking type, not Sourcing) at the exit end of the scale, and connecting to the input, as shown on the schematics at the back of this manual, the controller can terminate the weight cycle of a package the moment the leading edge of that package blocks the photo-eye. This eliminates the sequence of measuring the downward weight trend as the package is exiting the scale conveyor, therefore shortening the time required to weigh the package and distance required between each package. We label this photo-eye as "EWT1" (early weight terminate #1). For pacing logic this is photo-eye "C"

This sets the pitch of the package to the length of the scale conveyor. Once the leading edge of the first package blocks the photo eye, the next package can start onto the scale conveyor.

4.2.1.2 Two Photo Eyes

Weighing methods used in the 5511 do not accommodate placing a photo-eye at the entry of the scale conveyor and then running a timer to set termination of the weighing cycle. However, if a photo-eye exists at the exit end of the scale conveyor, another photo-eye can be placed at the entry of the scale conveyor to assist with weighing in certain applications. We label this photo-eye as "EWT2" (early weight terminate #2) For pacing logic this is photo-eye "B"

Even with an exit end photo-eye used to terminate weight cycle of a package, the 5511 still requires that criteria is met for the entry of each package into the scale conveyor. If the package is too light, say you run 50 lb. bags and a 1 lb bag, it may be extremely difficult to initiate a weight cycle on the 1 lb bag. Placing a photo-eye at the entry of the scale conveyor will force the weight cycle to begin.

The sequence of operation for this photo-eye includes the eye becoming blocked by the package entering the scale conveyor. No weight data is captured at this time. When the trailing edge of the package clears the in-feed photo-eye, weight samples are captured and stored. When the leading edge of the package blocks the exit-end photo-eye, weight samples are terminated, averaged and a weight displayed.

IF another package blocks the in-feed photo-eye while the first package is in transition across the scale conveyor, an error will occur. See 2 Bag Reject, below.

4.2.1.2.1 Three Photo-Eyes Option

Although not accessible from this menu, there is an option for a third photo-eye. This eye is placed several inches up-stream on the conveyor feeding the scale conveyor. Logic within the 5511/6611 uses this and the other two photo-eyes to determine if the next package approaching the scale conveyor is properly spaced or too close. If too close pacing logic is used to turn on an output to stop the conveyor feeding the scale long enough to allow the package on the scale to finish weighing. The pacing output is then turned off, allowing the up-stream conveyor to restart and dispense its package to the scale. See Section 4.7.3.1.6, below for instructions on use.

4.2.1.3 Empty Bag Reject

If the checkweigher scale conveyor has EWT1 (described above) photo-eye, and an empty or near-empty package crosses the conveyor, it may not have enough weight to start a weightment cycle. If a weightment cycle is not started and the exit end photo-eye (EWT1) is blocked by the package as it exits the scale conveyor, the 5511 recognizes this as an invalid or empty package. This menu button enables or disables a reject response to detection of an empty package. Press the button to toggle the choice.

4.2.1.4 Bag Reject

When using a photo-eye at the in-feed and exit end of the scale conveyor (EWT2) it is possible to detect when packages are too close together. The first package enters the conveyor, blocking the in-feed photo-eye. Once the trailing edge of the package clears this photo-eye the 5511 integrates weight data, until the exit end photo-eye becomes blocked. If another package blocks the in-feed photo-eye before the 1st package reaches the exit end photo-eye then the weightment of the 1st package becomes invalid since more than one package is on the conveyor at one time.

Some applications may realize this is a normal occurrence and decide it is best to ignore the occasional set of packages that are too close, and will disable this function.

Others may see this as an event that will require both packages to be removed and manually weighed or checked to verify compliance before sending down the packaging line.

Press this button to toggle the choice

4.2.1.5 Photo Eye Response

This button toggles between "Fast" and "Slow". Fast represents applications where photo-eye(s) on the scale conveyor are blocked quickly and only once by each package. For example, a cardboard box, carton of cereal, bottle, etc.

Slow is defined as an application where the package may block the photo-eye more than once per package, such as a FFS bag of product with a thin floppy tail at the front or end (or both) of the bag, open flaps on a box or carton, or multi-faceted packages that may reflect back to the eye more than one time per package. Choosing "Slow" for the response time then enables the next setting for time.

4.2.1.6 Photo Eye Response Time

With photo-eye response, above, set to "Slow", use this function to set a timer value in which multiple activations of the photo-eye may occur for any package. As an example a FFS bag filled with soup has a flexible tail at either end of the bag. The conveyor line is running at 50 fpm, and the tails at either end may block and unblock several times as the bag transitions across the conveyor. Setting this time to ½ second will allow the photo-eye to be activated multiple times within that ½ second, but the 5511 sees it as only one activation. This setting is empirical and must be set per application.

PHOTO EYE RESPONSE TIME (0 TO 2.5)		
CURRENT = 0.0 SEC		
0		
7	8	9
4	5	6
1	2	3
-	0	.
Enter Clear		
RETURN TO PREVIOUS		

4.3 Configure Reject Outputs

In the 3 or 5 zone checkweigher mode, packages crossing the scale are compared to a Target weight and reject limits. If the package weight falls outside of the acceptable limits a reject output or outputs are actuated. The default setting for the 5511 is to reject low-weight, high-weight and metal contaminated packages from the same common output, #8 on the Scale-I/O board. This menu setting allows for separation of either low and high weight or weight and metal contamination to outputs #8 and output #6. Output #8 is ALWAYS dedicated to low-weight reject or weight reject. When separate outputs are configured separate sets of timers will appear.

CONFIGURE REJECT OUTPUTS	
LOW REJECTS ARE ALWAYS DIRECTED TO:	
OUTPUT 8, CARD 1 (3)	
HIGH REJECTS = OUTPUT 8, CARD 1 (3)	
METAL REJECTS = OUTPUT 8, CARD 1 (3)	
CONFIGURE HIGH REJECT OUTPUT	
CONFIGURE METAL REJECT OUTPUT	
REJECT CONFIRMATION = OFF	
RETURN TO PREVIOUS MENU	

There are two timers associated with each reject output; reject delay and reject duration. Reject delay is the period of time from the moment the package is weighed to the position in front of the reject device. Reject duration is the amount of time to energize the reject output to operate the reject device or interface. NOTE: when interfacing to robots or PLCs the most common settings are 0.0 second delay and 0.3 second duration. This pulse is read by the other controls device, which then manages and operates the reject device.

NOTE: The 5511 can hold eight (8) consecutive sets of reject timers in memory, with a maximum reject delay of 25 seconds. If 8 packages rejected in a row, and the reject device were 25 seconds away, the 5511 will manage them all. If 9 or more packages reject in a row, the last package reject will be dropped.

Select either "Configure High Reject Output" or "Conveyor Metal Reject Output" and the following screen appears. Select Output 6 as the alternate reject output for this function.

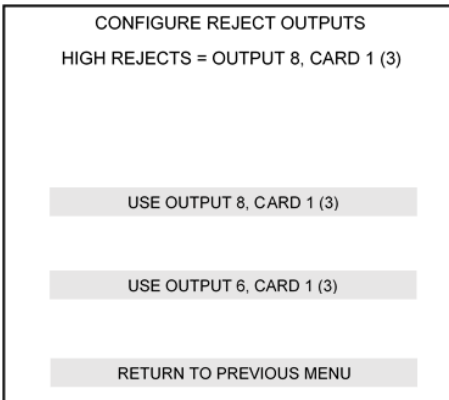

4.4 Initialize Audit Trail

If a new scale & I/O board is installed into the 5511 it must be initialized within the 5511 controller so that each calibration record can be properly stored. This should only be used when installing a new or replacing a #811, 812, 817 or 819 Scale & I/O board.

4.5 Set Number of Zones

When configured as a "Normal" checkweigher, the 5511 categorizes each weightment compared to a Target weight and reject limits. Traditionally categories for each weight were low-reject, good & high-reject. This is a standard 3-zone configuration.

Many applications require more definition of weight classification so increase the weightment zones from 3 to 5, adding low-pass and high-pass zones. These additional 2 zones can assist the operator with a quicker and more accurate response to changing weights. Using a 3-zone configuration, weights are either classified as good or bad (low or high). The 5-zone configuration adds more information, showing trending to the light-side or heavy-side of acceptable.

If several weights cross the scale and show a low-pass weight zone, the operator quickly realizes that an adjustment is most likely needed at the filling or packaging machinery.

4.6 Feedback

Program version 2.96 and later contains an option for closed-loop feedback to a single fill head operated by a servo controller. This version of feedback monitors package weights, determines trends in weight as compared to the Target weight, and provides adjustment pulses back to the fill controls. There is a positive pulse output and a negative pulse output to drive the filler to add more or less product to subsequent fills. The +/- pulse outputs are provided through the addition of the #819 Channel #2 I/O Board.

Product Recipes change when this feature is turned on

Entering into the Feedback screen displays the following:

FEEDBACK SETTINGS	
FEEDBACK MODE	OFF
INCLUDE REJECTS	NO
SET PULSE FEEDBACK WEIGHT	0.10
SET MAX NUMBER OF PULSES	10
RETURN TO PREVIOUS MENU	

4.6.1 Feedback Include Rejects

In some cases the user may or may not want to include any rejected weights in determining adjustment to the filler. Turning this function ON will include all weight values in the averaging used to determine adjustment to the filler. Turning this function OFF excludes low or high reject values from this population.

4.6.2 Set Pulse Feedback Weight

Each filling system is unique and the incremental weight value of a single pulse may vary from machine to machine. This value is set to equal the weight of a single pulse, and is used by the 5511/6611 controller to determine the number of pulses required to achieve a set correction value.

4.6.3 Set Max Number of Pulses

This value is by default set to 10. This keeps the checkweigher controller from driving too large a correction value to the filler, such as a case in which the filler becomes plugged and begins dispensing empty or near-empty containers. The amount of adjustment issued by the checkweigher may overwhelm the filler and/or drive a mass over-correction.

4.6.4 Checkweigher Recipe with Feedback

When feedback is enabled the global settings, shown above must be set. Settings unique to each recipe and product type are managed through the Checkweigher Recipe. Go to Select/Edit Recipe, enter the recipe number to edit, or create a new recipe, and then edit weights. The following screen appears:

SET FEEDBACK SAMPLE AND FREQUENCY COUNTS	
SET FEEDBACK SAMPLE COUNTS	5
SET FEEDBACK SAMPLE FREQUENCY	8
RETURN TO PREVIOUS MENU	

4.6.4.1 Set Feedback Sample Count

This value is the sample population used to determine the error from Target. As shown, 5 packages are weighed. Their values are added together, divided by 5, and the average compared to the Target weight.

4.6.4.2 Set Feedback Sample Frequency

This value is equal to the number of packages between the one just weighed at the checkweigher and the one just dispensed from the filler. The checkweigher will weigh and classify (pass/fail) these packages, but will not use their values to determine further adjustment to the filler. In this example 8 package weights will be passed, with the 9th package being the first of the next group to be in the sample population.

4.7 Configuring Global Settings

There are several configuration variables for timers and alarms that must be set prior to operating the checkweigher.



4.7.1 Set Time & Date

The calibration audit trail and other features use the time/date function. Select this button and the following screen will appear:

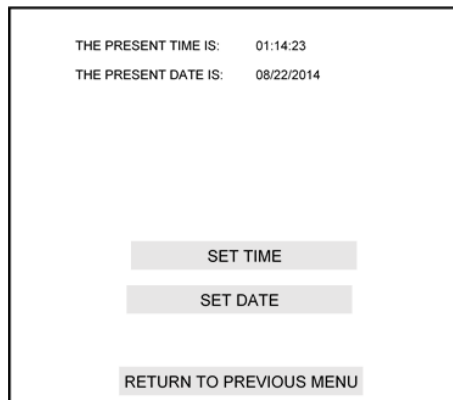

The user is prompted through setting hours, minutes and seconds for time, and day, month and year for date.

4.7.2 Set Reject Times

This configuration menu provides data entry boxes for reject delay and duration timers:



Checkweighers wired directly to the reject device will use the WEIGHT/METAL REJECT DELAY timer to set the amount of time it takes the package to reach the exit of the scale conveyor to the reject device. REJECT DURATION is the amount of time the reject device solenoid valve is actuated to drive the off-weight package from the production line.

Some checkweighers are integrated into the packaging line, with the supervisory system controls PLC operating the reject device. Typically in these cases the Reject Delay is set to 0.0 second. The Reject Duration is typically set to 0.3 second, driving a pulse input to the system PLC.

Checkweighers wired directly to the reject output of an up-stream metal detector or other sensor or device that can detect a rejected product other than by weight, can be connected to the checkweigher controller's input #6. When this input is turned on the timer for METAL DETECTOR DELAY will run, then the appropriate output turned on to reject the device.

4.7.3 Set Motor Parameters

Thompson Scale Company's Sonic 350 small package checkweigher uses a 24VDC servo motor to power each of the miniature conveyors used with this type scale. The Sonic 350SHD uses a 24VDC motorized drive roller, controlled by a variable speed controller module. Our Sonic 350MDR uses a different type of drive module that does not offer external speed control.

4.7.3.1 Cool Muscle Motor Settings

If your system is a Sonic 350 (no SHD or MDR suffix) Checkweigher, the brand name of the servo motors used are "Cool Muscle", and the style of motor settings required are shown below:

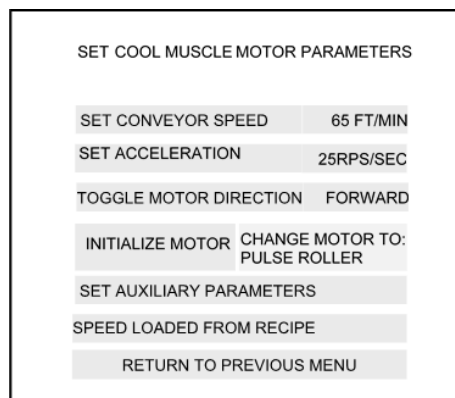

4.7.3.1.1 Set Conveyor Speed

A new box will appear, displaying a keyboard and prompt for entry of conveyor speed in Feet Per Minute. A valid range is available from 25 to 325 fpm. Enter the desired speed and press “Enter”

4.7.3.1.2 Set Acceleration

This box includes a setting for acceleration/deceleration of the conveyor motor. Acceleration is measured in the number of revolutions per second – per second. The default is 10, with a valid range of 2 (very slow acceleration) to 25 (snaps quickly to speed).

4.7.3.1.3 Toggle Motor Direction

This configuration setting toggles from “Forward” to “Reverse” and back. The default is “Forward”. If the conveyors are mirror images of the standard configuration, then selecting “Reverse” runs the motors in the opposite direction.

4.7.3.1.4 Initialize Motor

Servo motors used on the Sonic 350 Checkweigher have servo controls built within the motor. Typically when the motors are new and first-time use, they must be initialized to load all parameters and clear memory. There is no need to use this, unless a new motor has been added to the Checkweigher.

4.7.3.1.5 Change Motor to Pulse Roller

Selecting this variable presents a different screen of settings unique to the Sonic 350SHD Style checkweigher. These settings are discussed in section 4.7.3.2, below.

4.7.3.1.6 Set Auxiliary Parameters (Servo)

The Sonic 350 Checkweigher’s servo motors are typically tied together so they run at the same speed, have the same acceleration/deceleration, and operate in concert with one another. Choosing Auxiliary parameters gives you control of the INFEED conveyor of the three Sonic 350 conveyors. This conveyor can be run at a different speed and can be used to monitor packages as they enter the checkweigher. If packages are too close the in-feed conveyor can start/stop to pace packages to the scale conveyor. MAXIMUM PACING RATE IS 45 PACKAGES PER MINUTE.

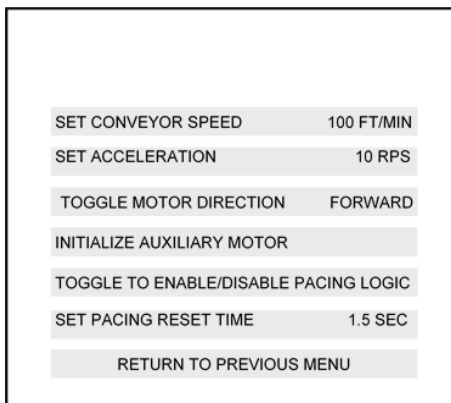

Settings for conveyor speed, acceleration, direction and initialization are the same as described above for the standard motor set.

Pacing logic is enabled or disabled by touching the “Toggle to Enable/Disable Pacing Logic” button. If enabled this function relies upon the use of photo-eyes, as described in section 4.2.1, above.

Pacing logic for the Cool Muscle motor is managed by photo-eyes connected to inputs, see I/O map at the end of this chapter, and by serial instructions transmitted from the 5511/6611 to run/stop the motors.

Set Pacing Reset Time is a value used to force a reset of the 5511/6611 tracking of packages. Sometimes packages may get out of sequence with the photo-eyes and there must be a method for resetting this logic. Faster-paced systems require a shorter reset time than slower systems.

4.7.3.1.7 Speed Loaded from Recipe

When using the Motor Parameters for the Sonic 350 or the Sonic 350SHD, a feature is available for setting the conveyor speed unique to each recipe. For applications running a 2 oz. package 3" long at a rate of 100 per minute and also a 20 oz. package 13" long at 20 per minute, variable speed control per recipe offers a real advantage for spacing and material handling. This button toggles between "Speed Loaded from Recipe" and "Speed Not Loaded from Recipe". If enabled, each recipe now contains a button for motor speed:

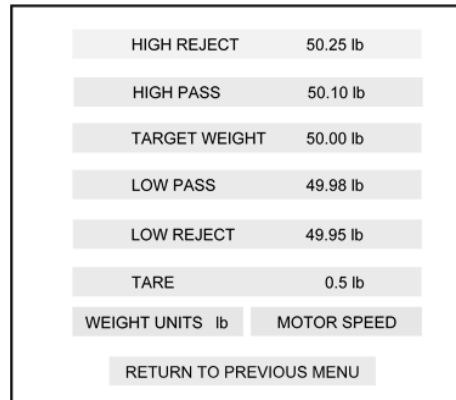

Touch on "Motor Speed", and the following screen is presented:

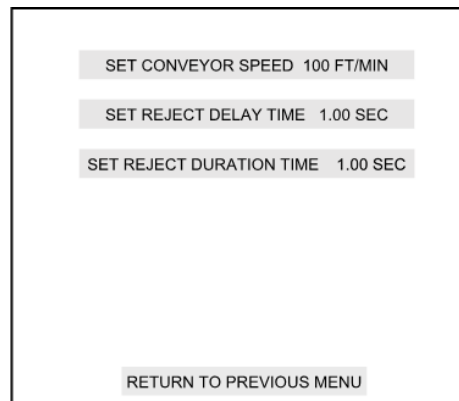

Set conveyor speed appropriate for the length of the scale and product length to allow for adequate weigh time.

Conveyor speed affects when each package will reach the reject device. Timers are presented to set a unique reject delay (from when a package is weighed to when it is at the rejecter) and reject duration (amount of time to actuate reject device). The global setting for "Set Reject Times" is disabled.

4.7.3.2 Pulse Roller Motor Settings

This group of settings is intended to be used with the #821 Analog Output board. The #821 board is a 2-channel serial input, analog; 0-10 VDC and 4-20mA output board.

In the checkweigher program this analog output is used to drive a motor controller module, such as the EZ-24 motor control module we use with our Sonic 350SHD and 5511si Intermediate checkweighers. It can also drive an analog input to a PLC or VFD to operate other motor controls. Follow instructions for the #821 Analog Output board for its calibration, then use these instructions to set up the Analog motor parameters, shown below.

When Analog Motor Parameters are selected, the following screen is displayed:

SET PULSE ROLLER MOTOR PARAMETERS	
SET CONVEYOR SPEED	65 FT/MIN
ENTER ½ CONVEYOR SPEED	58 FT/MIN
RUN AT ½ SPEED	RUN AT SET SPEED
NOT USED	CHANGE MOTOR TO: COOL MUSCLE
SET AUXILIARY PARAMETERS	
SPEED LOADED FROM RECIPE	
RETURN TO PREVIOUS MENU	

4.7.3.2.1 Set Conveyor Speed (Analog)

The values entered in "Set Conveyor Speed" and "Enter ½ Conveyor Speed" provide the 5511/6611 with information to allow for accurate speed control when setting speeds within each individual recipe. First actual speed must be determined. Using the motor control module, VFD, PLC or whatever device is used to run the conveyor motor, set to run at the maximum allowable speed for the application. This will be based upon the length of the scale conveyor, package length and acceptable weigh time.

Press the "Run At Set Speed" button, shown on the screen above, which will drive the #821 Analog Output board to 10VDC and 20mA, whichever you may be using. Use a tachometer to determine what the maximum speed of the conveyor is, enter that value into "Set Conveyor Speed".

Press the "Run at ½ Speed" button, and the output of the #821 board will now change to 5VDC and 12mA or half-scale. Use a tachometer to determine what half speed is, and enter it into the "Enter ½ Conveyor Speed".

Many motor controllers are not linear, so ½ conveyor speed may not actually be ½ of the full conveyor speed.

With these 2 values set the 5511/6611 can now provide accurate speed control for the conveyors.

4.7.3.2.2 Set Auxiliary Parameters (Analog)

The Sonic 350SHD Checkweigher's motors are typically tied together so they run at the same speed, have the same acceleration/deceleration, and operate in concert with one another. Choosing Auxiliary parameters gives you control of the INFEED conveyor of the three Sonic 350SHD conveyors. This conveyor can be run at a different speed and can be used to monitor packages as they enter the checkweigher. If packages are too close the in-feed conveyor can start/stop to pace packages to the scale conveyor. MAXIMUM PACING RATE IS 45 PACKAGES PER MINUTE.

SET PULSE ROLLER AUXILIARY MOTOR PARAMETERS

SET CONVEYOR SPEED	100 FT/MIN
NOT USED	
NOT USED	
NOT USED	
TOGGLE TO ENABLE/DISABLE PACING LOGIC	
SET PACING RESET TIME	1.5 SEC
RETURN TO PREVIOUS MENU	

Pacing logic is enabled or disabled by touching the “Toggle to Enable/Disable Pacing Logic” button. If enabled this function relies upon the use of photo-eyes, as described in section 4.2.1, above.

Pacing logic is managed by photo-eyes only, connected to inputs in the 5511/6611 - see I/O map at the end of this chapter.

Set Pacing Reset Time is a value used to force a reset of the 5511/6611 tracking of packages. Sometimes packages may get out of sequence with the photo-eyes and there must be a method for resetting this logic. Faster-paced systems require a shorter reset time than slower systems.

4.3.4 Trend Alarm/Good Weight Settings

This setting combines a number of different functions, sharing a single output. Only one of the choices can be enabled at any one time.

OUTPUT 7 IS SHARED BY:
TREND ALARM, GOODWEIGHT, ANYWEIGHT, REJECT
CONFIRMATION-ONLY ONE CAN BE SELECTED AT A TIME
PRESENT SELECT IS TREND ALARM

REJECT CONFIRMATION
TREND ALARM
SET GOODWEIGHT SIGNAL
SET ANYWEIGHT SIGNAL
SET ALL OFF
RETURN TO PREVIOUS MENU

4.3.4.1 Reject Confirmation

This configuration will monitor a sensor associated with a reject device, verifying that the package has been rejected. Typically this is done with a photo-eye, with the package blocking and then unblocking the eye within a 2 second period of time. If the checkweigher controller actuates the reject output and does not detect the presence of the rejected object, output #7 will come on to alarm the condition. Additionally, if the package blocks and does not clear the sensor within 2 seconds it will be assumed that the area holding rejected packages is full or jammed. The alarm will be actuated for this condition. Finally an error is displayed on-screen, just below the package weight. The error message is removed once the condition has been addressed

4.3.4.2 Trend Alarm Condition

A trend alarm delivers an alarm output whenever a specific set of weight events occur. This may be a consecutive number of low-weight rejects, or high-weight rejects, or both. A screen is presented where values can be entered, as well as timers for the duration of time to actuate the alarm output.

This feature is important for high production rate lines where a filling or dispensing machine malfunctions and generates a number of reject packages. The trend alarm will alert the line operator to the condition before the situation gets out of control.

Settings for Trend Alarm:



4.3.4.3 Goodweight Settings

The good weight signal can be used alone or in conjunction with the reject outputs to deliver an output from the checkweigher controller for 100% of the product running across the scale. Two timers are associated with this setting; delay and duration, as used with the reject outputs. Set these values to deliver the interface signal with the delay and duration of time required by the application.

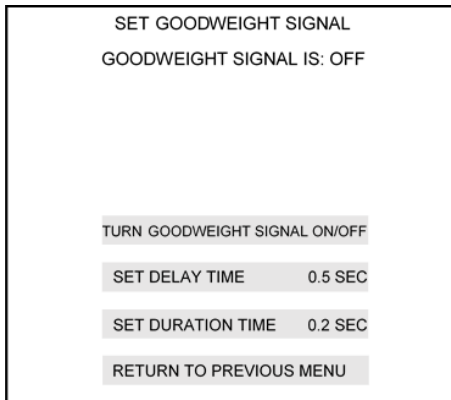

4.3.4.4 Anyweight Settings

This interface generates an output on #7 for every package; good or bad, crossing the scale. Two timers are associated with this setting; delay and duration, as used with the reject outputs. Set these values to deliver the interface signal with the delay and duration of time required by the application.

SET ANYWEIGHT SIGNAL
ANYWEIGHT SIGNAL IS: OFF

TURN ANYWEIGHT SIGNAL ON/OFF

SET DELAY TIME 0.5 SEC

SET DURATION TIME 0.2 SEC

RETURN TO PREVIOUS MENU

4.4 Entering a Recipe – for a Checkweigher

The 5511 is capable of holding 100 recipes in memory. Recipes contain pertinent information on the product name, target weight and other variables unique to this product. The following section is broken into recipe management for checkweighers.

From the main screen, press the “Tools” icon:

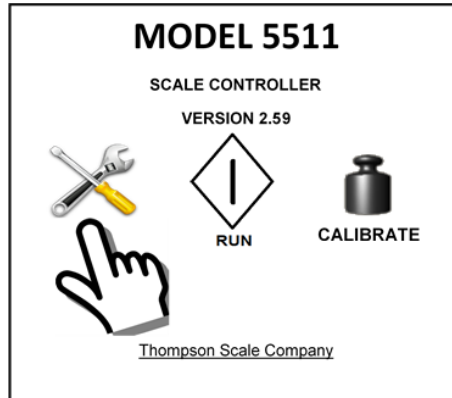

The main configuration menu is displayed:

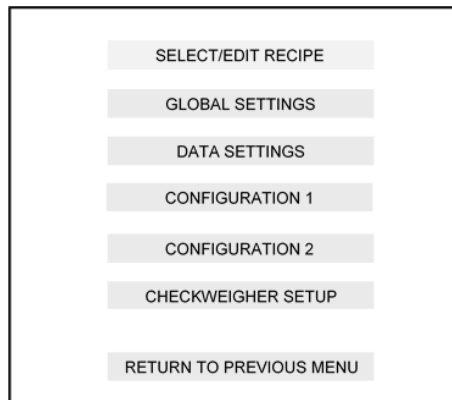

Press the “Select/Edit Recipe” button, and a new screen will appear:



4.4.1 Enter New Recipe

Up to 100 recipes can be stored in non-volatile EEPROM within the 5511. When the controller ships from the factory one recipe (001) is programmed to provide a starting point. When a New Recipe is selected for entry it assumes the next numeric position in the list of recipes. That is to say, if recipe 001 is the last recipe, and the user enters a new recipe, it will be 002. It is not possible to randomly access or enter recipes in memory.

EDIT RECIPE NUMBER 003

- RECIPE NAME
- RECIPE DESCRIPTION
- EDIT WEIGHTS
- NOT USED
- SAVE RECIPE
- RETURN TO PREVIOUS MENU

4.4.2 Select/Edit Old Recipe

Recipes held in memory can be accessed and edited. This menu choice provides a prompt to enter the recipe to edit.

In either case, the following screen is displayed for checkweighers. Please note that the Low Pass and High Pass zones are not displayed, if the 5511 is configured as a 3-zone checkweigher.

The Recipe Name and Recipe Description Fields can contain up to 40 characters, and should be a descriptive name that helps the operator identify the product being run.

HIGH REJECT	50.25 lb
HIGH PASS	50.10 lb
TARGET WEIGHT	50.00 lb
LOW PASS	49.98 lb
LOW REJECT	49.95 lb
TARE	0.5 lb
SELECT WEIGHT UNITS	lb
RETURN TO PREVIOUS MENU	

Enter the Target weight and reject limits to suite the application needs. If the checkweigher has been configured as a 3-zone scale the Low Pass and High Pass zones will not appear.

Once the values have been entered, it is **EXTREMELY IMPORTANT** to do the following:

Press the "Return to previous menu" button ONCE

Select the "LOAD PRODUCT TO RUN", if you want this product recipe to be loaded and become the currently running recipe for the checkweigher

OR

Select "RETURN CHANGES SAVED". This is in the lower right corner of the screen. The changes will be saved but NOT loaded.

OR

Select "RETURN CHANGES NOT SAVED". This is in the lower left corner of the screen, and will abort any changes made.

Like a personal computer, the operating system has a variety of programs installed and ready for use, BUT the programs do not become active until the user clicks on an icon and loads the program to run. The 5511 is very similar in this respect. Even though there may be 100 recipes in memory, only one is loaded and is the active and running program.

There is also a prompt on the Run screen, in the bottom right corner, "RECIPE NUMBER". Touch this button and a screen is displayed for the operator to enter and load a new recipe.

<div style="border: 1px solid black; padding: 5px; display: inline-block;"> 50.86 ^N_g </div>				
<div style="border: 1px solid black; padding: 2px; display: inline-block;">0.00</div>				
LOW REJECT	LOW PASS	GOOD	HIGH PASS	HIGH REJECT
57	258	258357	357	58
Total Weight 1308393.50		Average 50.50	Total Units 259087	
RED WIDGETS			TARGET 50.50 lb	
			TARE 0.60 lb	
<div style="border: 1px solid black; padding: 2px; display: inline-block;">MAIN MENU</div>		<div style="border: 1px solid black; padding: 2px; display: inline-block;">ZERO</div>	<div style="border: 1px solid black; padding: 2px; display: inline-block;">RECIPE NUMBER 2</div>	

4.4.3 Editing an Existing Recipe

From the "Select/Edit Recipe" button in the Tools Menu, a screen for entering the recipe to be edited is displayed:

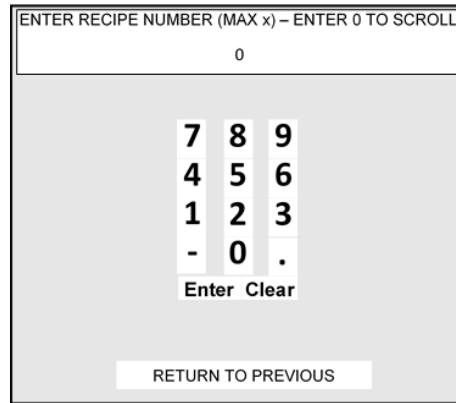

If the user does not know which product to edit, press the "0" button, then Enter. All active recipes will be displayed. Scroll through the recipes, then select by the number at far left:

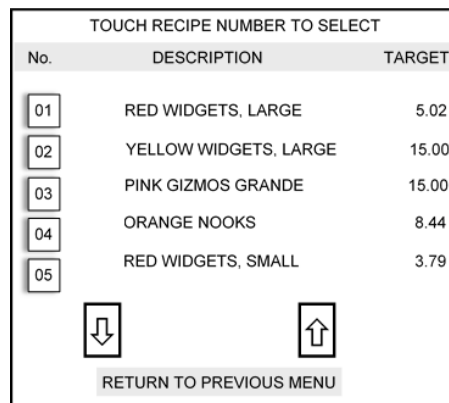

4.5 Checkweigher Run Screen

Press "Return to Previous Menu" from anywhere within the program, and eventually the Main Menu screen will appear. Select "RUN" to enter the Checkweigher run screen:

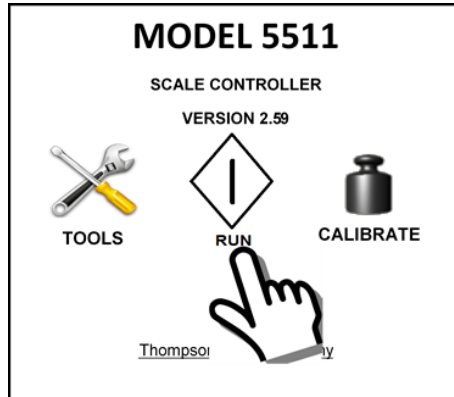

Shown below is an example of the 5-zone checkweigher screen:

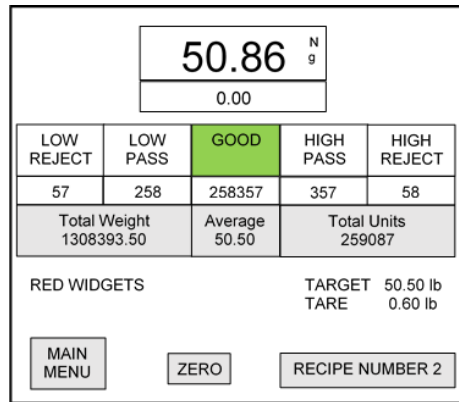

The 3-zone Checkweigher omits the "Low Pass" and "High Pass" zone boxes

Pressing the "Recipe Number" button will display a screen where the operator can quickly enter and select any existing recipe to run.

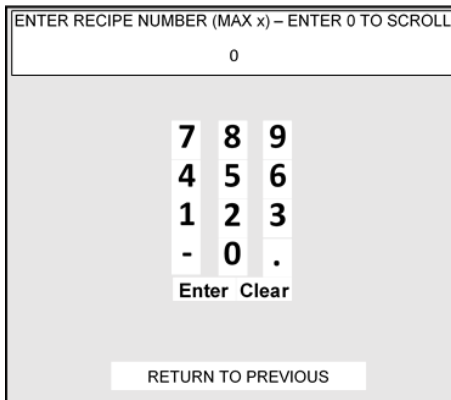

The operator can select a recipe, and can scroll through recipes, but cannot edit the recipes from this screen.

4.6 Checkweigher I/O Map

The 5511/6611 can be configured with 1, 2 or 3 scale & I/O boards. As each is added an address jumper is added to each card's input terminal block. Card #1 has no address jumper, card #2 has a jumper from common to pin 10, card #3's jumper is from common to pin 11, and card #4 is common to 10 and 11.

These jumpers help the mother board to determine the place and functionality of each scale & I/O board. These functions are:

Card #1

INPUT	FUNCTION	OUTPUT	FUNCTION
1	Reject Inhibit (ON inhibits reject output)	1	Low Reject Zone output (continuous)
2	Metal Detector Reject Input	2	Low Pass Zone output (continuous)
3	Servo Motor Run Enable ON=Run	3	Good Weight Zone output (continuous)
4	"A" Photo-Eye for Pacing (on upstream conv)	4	High Pass Zone output (continuous)
5	Not Used	5	High Reject Zone output (continuous)
6	Reject Confirmation Photo-Eye	6	Metal Reject or Dedicated High Reject (timed)
7	"B" Photo-eye (in-feed scale conveyor)	7	Trend/Good Wt./Any Wt. (timed)
8	"C" Photo-eye (out-feed scale conveyor)	8	Reject (default low & high) (timed)

Card #2 is used when the checkweigher is configured as a dual-lane checkweigher and has identical I/O to card #1, but dedicated to scale #2

Card #3

INPUT	FUNCTION	OUTPUT	FUNCTION
1		1	Feedback Pulse Positive
2		2	Feedback Pulse Negative
3		3	
4		4	
5		5	
6		6	
7		7	
8		8	

All other I/O are not defined in version 2.96

Card #4 is not defined in version 2.96

Chapter 5

Filler Controller Setup

The 5511/6611 can be configured to operate a variety of fill-by-weight packaging machines. As of version 2.96, the following machine types are available:

- Gross packer, with specific options for Air, Impeller and Auger
- Net weigh scale, with specific options for single, multiple dump, pass-through and count
- Generic filler
- Bulk box filler
- Bulk bag filler; type 1 and 2
- Liquid container filler
- Top Off filler
- DWM filler emulation
- “Weightless” filler

To access the different types of filler programs, remove power from the 5511 controller, then remove any I/O boards so there is clear access to the 810 (6611) or 815 (5511) processor board.



WARNING: THIS EQUIPMENT IS TO BE INSTALLED AND SERVICED BY QUALIFIED SERVICE PERSONNEL ONLY

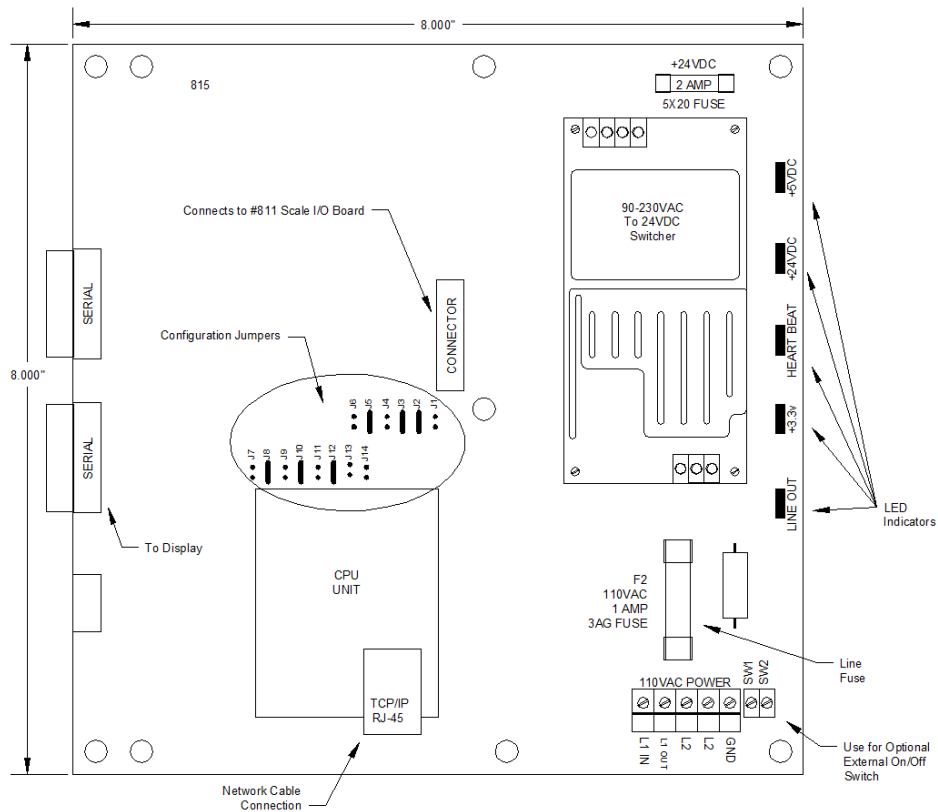

Jumper J10 should be in place to designate the controller is configured as a filler controller
 Jumper J11 is moved to J12 to enable configuration of a specific type of filler

Turn power on and go to the Tools Menu, then “Filler Controller Setup”. Upper Left corner of the screen will show the filler type. Press here to display all filler types

5.1 Selecting Filler Type

Upon moving the programming jumper on the 810 or 815 processor board from J11 to J12 (with power off) the user will enable the 5511 controller for selecting a filler type.

Apply power to the controller and select "Tools" icon from the main screen. Select Filler Setup from the menu.

Select the filler type shown in the upper left corner of the screen. The example below shows this screen configured for a gross filler:

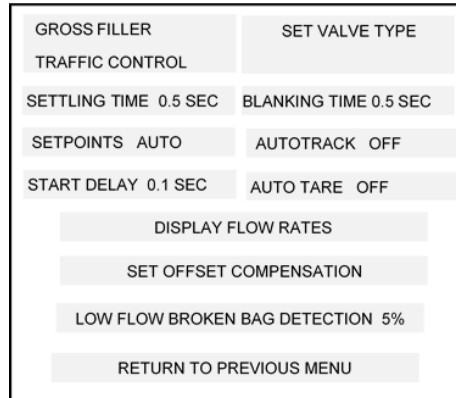

Touching "gross filler" box will bring up the filler selection display:

Select the filler type of interest, then select "return to previous menu" until the main screen is displayed.

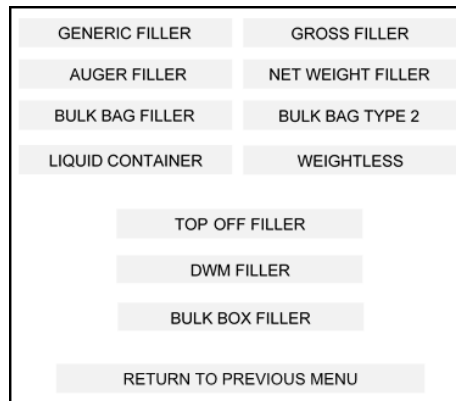

Remove power from the 5511 enclosure, then move the J12 jumper back to J11. Upon powering up the controller the selected filler type will be the only type available.

5.2 Configuration settings for your filler

The 5511 has configuration settings that are common to all filler types. Reference Chapter 2 for configuration settings that affect the scale functionality of the controller directly. These settings include sample rates, filter frequencies, resolution, increments, etc.

5.2.1 Set valve type

Different manufacturers of fill-by-weight equipment use different techniques for operating the Bulk and Dribble (if available) actuators on the machinery. The 5511 offers several types of fill valves or actuators:

SET VALVE TYPE
PRESENT VALVE TYPE IS:

#1 COMBINATION BULK AND DRIBBLE VALVE

#1 COMBINATION BULK AND DRIBBLE VALVE

#2 SEPARATE BULK AND DRIBBLE VALVES

#3 SEPARATE BULK AND DRIBBLE VALVES
BUT BOTH ARE TURNED ON DURING BULK

#4 AUGER FILLER REVERSING MOTOR

NOT USED

RETURN TO PREVIOUS MENU

5.2.1.1 Combination Valve

Bulk and Dribble outputs; #1 & #2 are turned on for Bulk, then Bulk output - #1 is turned off to provide Dribble fill. Many slide gates or gravity feed gates operate this way, and require both Bulk and Dribble solenoid valves to actuate to provide a Bulk fill position.

5.2.1.2 Separate Valves

This setting is meant for a system with a Bulk gravity feed gate and a Dribble vibratory feeder, or two separate vibratory feeders, or two belts feeding the scale. A Gross packer may have two opposed air cylinders, both retracted for Bulk, one returned to partially block the fill tube and provide reduced or Dribble flow.

5.2.1.3 Special Combination Valve

This valve is for specifically configured combination feeders that will allow the feeder to go straight to Dribble without needing Bulk to be actuated. These valve or actuator types may be used on fillers that weigh and fill both large and small doses of product.

5.2.1.4 Auger with Reverse

This configuration is specifically for use with a vertical or horizontal auger filler, and offers a plug-reverse output at the end of the fill cycle. This plug-reverse stops the flow of product and can also prevent floppy products from creeping past a stopped auger. This is used in conjunction with the setting for Auger Reverse Time.

5.2.2 Set Settling Time

Settling time is invoked at both the beginning and the end of each fill. Once the filler machine is ready to begin filling, a timer is run to allow the filler and its mechanisms to come to rest before the filler controller takes a TARE. Once the timer expires, the 5511 takes the next scale reading as a reference, and zeros the filler.

This TARE is stored and used only for this particular fill. This is done since air, auger, and impeller packers, and bulk bag & box fillers may have variations in the empty container weight for each fill.

When the fill is complete, the Settling Time is invoked again, finding a stable scale reading and using it as the final "checked" weight of the fill. TARE, stored at the beginning of the fill is subtracted, and a final Net weight is displayed before discharge of the filled container.

Settling time is set to 1.0 second as a default. Since many machines may settle much faster than 1 second, a variable is provided to allow adjustment from 0.1 to 5.0 seconds.

5.2.3 Set Blanking Time

In some applications for net weigh scales, bulk bag and box fillers, there is a significant "bounce" imparted into the scale when the material stream changes from Bulk to Dribble. This disturbance may be significant enough that the 5511 controller falsely detects an over-weight error and aborts the fill. Setting blanking time during this transition time will suppress weight readings from the filler controller's program, and allow for a smooth transition from Bulk to Dribble feed. This timer is a default value of 0.0 second. The timer can be set in increments of 0.1 second, up to a maximum of 5.0 seconds.

5.2.4 Set Points Auto/Manual

Fill-by-weight applications traditionally deliver product into a container with a fast fill, followed by a slow fill and a compensation or adjustment for influence of the product column flowing into the container, usually referred to as Preact. The 5511 offers the traditional method of setting a Bulk (fast fill), optional Dribble (slow fill) and Preact value for each product recipe. The user determines the proper cut-off point for fast fill and slow fill and derives a value for the Preact so that the end result is a fill that has reached the Target weight.

The 5511 also offers a more automated process called Automatic Set Points. Using this method, the user enters only the Target weight for the fill. When the first fill is run on the machine the 5511 automatically runs Bulk fill for a short pre-defined time, then runs in the Dribble mode for a short time, and then stops the fill after only a few seconds. Calculations are then made to determine Bulk cut-off, Dribble cut-off and Preact values. The first fill is then completed and the weight is checked just before issuing a discharge

The next fill will be based upon the checked final weight and adjustments are automatically made to the Bulk and Dribble cut-off points and Preact. Each fill's final weight is stored in memory and used to determine adjustment for the next fill.

This Automatic Set Point mode is very accurate and reliable, and automatically tracks and adjusts for progressive changes to bulk density, flow rates and product depletion from supply bins. It does not make large or drastic corrections, so cannot compensate for large unexpected changes to flow or density.

5.2.5 Autotrack – ON/OFF

Works for both Manual and Automatic Set Points, and enables or disables the 5511's ability to track changes in material characteristics during the fill process. It is recommended to always enable Autotrack, although there are times when flow is erratic, at the end of a supply bin or testing is being conducted where this function is best disabled.

Reference Entering A Recipe for a Filler, below, and look to the Autotrack button. This value determines the number of samples used to make adjustments to set points. Setting this value low, to say 3 or 4 samples, will yield a quick response to changes, but may be too small a statistical sample to use and may lead to erratic or over corrections. Setting the value too large, say to 10, will require a larger statistical sample and smaller corrections because the average and error are filtered by the larger sample. We recommend a value of 5 to start with, then adjust as needed for a particular application.

5.2.6 Start Delay

If the filler is configured with Auto TARE turned off or set on, but with multiple fills per TARE value set to more than 1, the fill process will start immediately once the Start input is driven ON. In some cases the operation of the equipment may not have fully clamped the bag, or other function may not be complete and ready for product release. Setting this value to more than 0.0 second will invoke a delay time at the beginning of the fill.

This function is not available for bulk bag or bulk box filling operations.

5.2.7 Auto TARE – ON/OFF

There are two methods for acquiring a TARE in the 5511. The first is manual (OFF), in which the operator enters or creates a TARE value. The other is automatic (ON) and the 5511 captures the TARE for the operator.

Set to OFF, or the Manual mode, will present a setting for TARE within each product recipe. See the section below on recipe entry. The operator enters the Target weight, timer settings, etc., and enters a numeric value for TARE. This mode is most often used for applications with consistently sized and weight empty containers used in the fill process.

The RUN screen also contains a TARE button, below the totals boxes, to the left. For Gross packers (air, impeller, auger) the operator can place an empty bag onto the fill spout, then press the TARE button. The value will be stored and used as part of all subsequent fills. If the Zero button, also in the RUN screen, is pressed it will clear the TARE.

Set to ON, or the Automatic mode, will present the following screen:

SET AUTO TARE ON OR OFF
PRESENTLY SET TO ON

SET AUTO TARE TO OFF
SET AUTO TARE TO ON
SET NUMBER OF FILLS PER TARE 25

RETURN TO PREVIOUS MENU

If this is set to ON, each fill will include a short time delay of just under ½ second for weight samples to be gathered and averaged to determine the weight of the container. The 5511 will then TARE this value out, starting the display at a zero value.

The number of fills per TARE is a routine that helps accelerate the filling cycle, if the controller is set to Automatic TARE. Normally a new TARE is taken at the beginning of every fill cycle. For example, a container is placed on the scale, under the fill nozzle, Settling Time is run and expires, ½ second of values are gathered and averaged to create a TARE value, then the fill begins.

This sequence works very well for applications where there are variances in the container, such as blown glass or roughly molded plastic containers, or if product is spilled and accumulates as part of the normal fill process. However, if the user is attempting to achieve the fastest possible fill cycle, this routine will slow the process just a bit.

Setting the "Fills Per TARE" to 1 will force a TARE at the beginning of every fill. Setting the TARE to 2 or more will cause the 5511 to take a TARE on the first fill, take a TARE on the 2nd fill, then average the two TAREs and use that value for the next number of fills entered. So, two fills with TARE, then 2, up to 99 fills using this calculated value.

5.2.8 Display Flow Rates

This function is not a variable, but a display of history for the last 10 fills. This screen displays the fill rate and time in Bulk only or in Bulk & Dribble fill, as the controller may be configured. Each new fill is added to the top of the list, pushing the last fill in the queue off screen.

The value of this information is found in following trends or inconsistencies in the fills and fill weights. Adjustments to bulk or dribble feed rates; adjusting flow, bed depth, air pressure, impeller speed, etc. will be displayed to allow the user to see changes/improvements as they occur.

As a troubleshooting tool Flow Rates are invaluable. If fill weights are inconsistent the user can set the 5511/6611 controller to manual set points, turn off auto tracking and turn off auto TARE. The fills will then be based only upon simple set points created within the recipe and eliminate influences from any auto tracking or TARE from the controller. If fill weights remain inconsistent, look to the mechanism feeding product to the filler and adjust speeds/pressures, etc. to achieve the most consistent fill possible.

HINT: flow rates are most inconsistent as product levels in the hoppers above the scales fall or change dramatically. Try maintaining a constant level in the bins to achieve the best fill results.

5.2.9 Offset Compensation

Offset compensation allows adjustment of the final fill weight displayed verses the actual weight of the bag.

Even though the 5511/6611 controller does an outstanding job, influences from variances in each filler, and the time allowed for capturing a zero and final fill weight can cause the final displayed weight to be slightly different from actual weight.

The compensation routine allows you to induce a negative (minus) compensation or positive (plus) compensation to the filler. For example;

The final displayed weight of a bag is 50.10, but the checked weight of that bag is 50.50. You would want to invoke a Minus compensation of 0.8%. This would make the displayed weight value increase to 50.50 lbs., matching the checked weight.

Offset compensation should only be used if the different between displayed weight and actual weight are consistent. If displayed weights vary randomly from checkweighed weights, there are most likely other problems such as varying flow rates, mechanical interferences, or electronic stability problems. Do not use Offset Compensation to try and correct these other hardware problems.

5.3 Generic Filler

This configuration delivers the most simple fill process possible, whether set to Automatic or Manual Set Point, and drives outputs for Bulk (fast), Dribble (slow) fill and an interface output called "filling". This filler type is used in conjunction with a PLC that controls all of the peripheral devices and sequencing for a complex or integrated filling system, with the 5511 providing the fast-response and automatic tracking of the actual fill process.

Input #	Input Description	Output #	Output Description
1	Start Fill	1	Bulk Fill
2	Stop Fill	2	Dribble Fill
3	Not Used	3	Filling

The 5511 is available in a configuration with an 815 CPU board, 817 Scale-I/O board and 816 Ethernet IP module. Connection through the EIP module to specific Allen-Bradley® PLCs provides fast-response command set interchange of all pertinent system variables, allowing the 5511 to drive display information through the PLC and eliminating the need for a display dedicated to the 5511.

GENERIC FILLER	SET VALVE TYPE
SETTLING TIME 0.5 SEC	BLANKING TIME 0.5 SEC
SETPOINTS AUTO	AUTOTRACK OFF
NOT USED	AUTO TARE OFF
DISPLAY FLOW RATES	
SET OFFSET COMPENSATION	
NOT USED	
RETURN TO PREVIOUS MENU	

Start Delay, described above in Section 5.2, is not available for this type filler configuration.

5.4 Gross Air/Impeller Filler

An air or impeller filler is typically considered a Gross filler, although the 5511 provides the opportunity to TARE out the empty package weight. I/O and sequencing for operating all devices on this style filler, and interfaces to placers or robots, are included.

Input #	Input Description	Output #	Output Description
1	Start Fill	1	Bulk Fill
2	Hold/Stop Fill	2	Dribble Fill
3	Bag In Place	3	Refill Valve
4	Not Used	4	Exhaust Valve
5	Not Used	5	Bag Clamp
6	Not Used	6	Chair Discharge
7	Not Used	7	Spout Blast/Purge
8	Discharge Inhibit	8	Placer Interlock

Sequencing includes:

- Placer Interlock actuated to request a new bag
- Place bag on fill spout
- Drive Input #1 ON momentarily or continuously
- Bag Clamp Actuates
- Refill valve timer elapses, valve closes
- Exhaust valve changes state from vent to pressure, pressurizing chamber
- Spout Blast actuated for timer value entered
- Bulk/Dribble outputs energized, per user configuration of valve type
- Fill completes; Bulk/Dribble outputs de-energized
- Settling Timer Elapses, final weight taken (1/4 second sample time)
- Spout Purge actuated for timer value entered
- Exhaust valve energized to vent chamber
- Refill valve output energized to start refilling chamber
- Bag Clamp released
- Bag Chair actuated for timer value entered

Actuating Input #2 (Stop) at any time during the fill sequence will place the filler into a “hold” mode. The bulk/dribble outputs are turned off, the exhaust valve is actuated for the time set, and the refill valve output is de-energized to open the valve. Actuating the Input again will abort the fill – release the bag clamp and actuate the chair discharge output.

This function allows the user to suspend the fill process and open the refill valve to charge the pressure chamber with additional product. A useful function for processes with a very small supply hopper above the filler or processes where feed stock to the filler runs out and the operator must wait for additional product to continue the fill process.

To restart the fill, actuate Input #1 (Start). If an automatic start switch is used when the bag is placed on the fill spout and may hold Input #1 ON through the fill process make the restart button a Normally Closed contact. Pushing the button will open the circuit, then actuate Input #1 when the button is released.

GROSS FILLER	SET VALVE TYPE
TRAFFIC CONTROL	
SETTLING TIME 0.5 SEC	BLANKING TIME 0.5 SEC
SETPOINTS AUTO	AUTOTRACK OFF
START DELAY 0.1 SEC	AUTO TARE OFF
DISPLAY FLOW RATES	
SET OFFSET COMPENSATION	
LOW FLOW BROKEN BAG DETECTION 5%	
RETURN TO PREVIOUS MENU	

5.4.1 Gross Filler Traffic Control

When the 5511 is configured as a 2-spout, or the 6611 is configured as a 2, 3 or 4 spout controller an option appears for managing discharge of bags from the fill spouts. Traffic control times and inhibits the discharge of bags to ensure that bags are not too close or fall on one another as they move from the filler to the take-away conveyor and processes down-stream.

In the upper left corner of the Filler Controller Setup screen is Traffic Control. Select this item, and the next screen will appear:

TRAFFIC CONTROL IS ON
PRODUCT FLOW IS LEFT TO RIGHT
SET DELAY TIMERS
SET DURATION TIMER 0.5 SEC
NOT USED
NOT USED
RETURN TO PREVIOUS MENU

Selecting the first line will toggle the feature on and off.

Product flow can be either left-to-right, or right-to-left, and will toggle as this item is selected

Delay timers are set in the following screen:

SET TRAFFIC CONTROL DELAY TIMERS
LEFT TO RIGHT DELAY TIMERS
DELAY SPOUT 1 TO SPOUT 2 0.2 SEC
DELAY SPOUT 1 TO SPOUT 3 0.5 SEC
DELAY SPOUT 1 TO SPOUT 4 0.8 SEC
DELAY SPOUT 2 TO SPOUT 3 0.2 SEC
DELAY SPOUT 2 TO SPOUT 4 0.5 SEC
DELAY SPOUT 3 TO SPOUT 4 0.2 SEC
RETURN TO PREVIOUS MENU

Even if your equipment only has 2 or 3 fill spouts timers for a maximum of 4 spouts are shown. Leave timer values at 0.0 for unused spouts. Delay timer for spout 1 to spout 2 amount of time from the instant the bag chair is actuated for spout #1 to the instant the bag from spout #1 enters the area of interference for spout #2.

The next timer is a continuation of time from discharge from spout #1 to an area of interference of spout #3, and then to spout #4, if any.

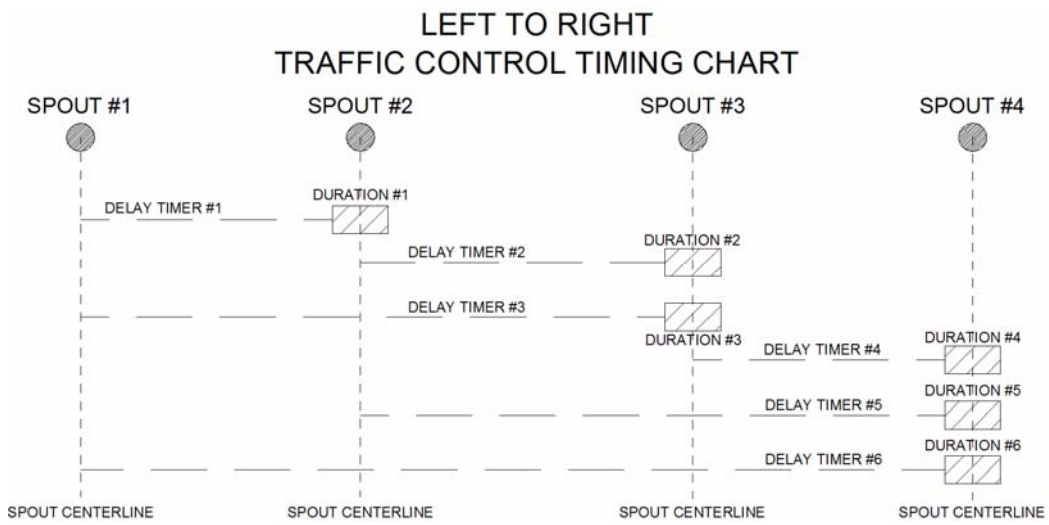

We recommend setting all timers to 2 seconds, then monitoring production and adjusting timers up or down to achieve the most efficient spacing and timing.

5.4.2 Low Flow Broken Bag Detection

Applications using an automatic bag placer and filling equipment not constantly attended by an operator may experience an event in which a bag placed on the fill spout is either mis-spouted, breaks or falls from the fill spout during the fill. This can result in hundreds or thousands of pounds of product being spilled from the filler as it attempts to fill the bag.

Two methods are provided in the 5511/6611 controller to address this potential issue. Within the main fill screen for the Air/Impeller/Auger style filler configuration a variable for "Low Flow Rate" is presented.

This setting allows the user to select the proper rate of change for their particular product or application. Some products fill much faster than others, while some products actually present periods of time during the fill that may actually present a negative rate of change. In particular, auger fillers or fillers greatly influenced by the bag, product or fill method may see a zero or negative flow rate change.

If the rate of change method for detecting a broken bag is not to be used select "OFF".

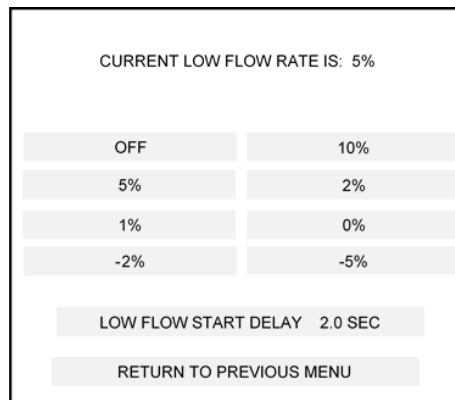

The second type of broken bag detection is within the recipe, along with target weight and several variables specific to the recipe. This broken bag detection method is based upon time alone. If the fill does not complete within the time value set in the recipe the fill will be aborted.

5.4.3 Recipe Entry

Once the 5511 has been configured as a filler, and choices for the type of filler and type of valve have been made, a recipe must be created to run the filler and its peripheral devices; fill valves, bag clamps, etc. The descriptions of different filler and valve types are discussed earlier in this chapter. Access to the Product Load and recipe edit screens are the same for most filler types:

Within the "Tools" icon are several configuration menus, settings for defining the filler type, and a Product Load button. Select this button to create new recipes or access existing recipes to edit.



ENTER NEW RECIPE

EDIT OLD RECIPE

RETURN TO PREVIOUS MENU

If a new recipe is selected, the next sequential recipe number will be assigned. If an old recipe to edit is selected the user is prompted to select the recipe to edit.

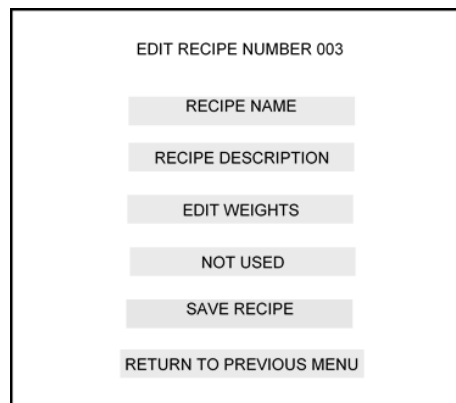

EDIT RECIPE NUMBER 003

RECIPE NAME

RECIPE DESCRIPTION

EDIT WEIGHTS

NOT USED

SAVE RECIPE

RETURN TO PREVIOUS MENU

A recipe name and description can be entered, up to 40 characters in length:

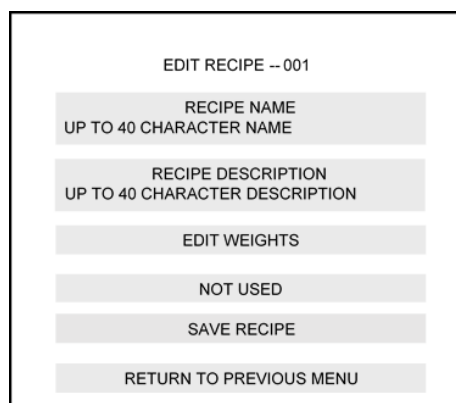

EDIT RECIPE -- 001

RECIPE NAME
UP TO 40 CHARACTER NAME

RECIPE DESCRIPTION
UP TO 40 CHARACTER DESCRIPTION

EDIT WEIGHTS

NOT USED

SAVE RECIPE

RETURN TO PREVIOUS MENU

After entering recipe name and description, select "Edit Weights":

TARGET WEIGHT	50.00 LB
BULK/DRIBBLE	B&D
VIBRATOR ON/OFF	ON
AUTO TRACK RESPONSE	5
SET TIMERS	
NOT USED	
NOT USED	
RETURN TO PREVIOUS MENU	

Enter the target weight, settings for bulk only or bulk & dribble, and if your equipment is equipped with a vibratory settler on the bag chair, enable (turn ON and set a value). Other recipe variables include:

ENTER GROSS PACKER TIMERS	
REFILL TIMER	2.2 SEC
BLAST AIR TIME	0.0 SEC
SPOUT PURGE TIME	0.0 SEC
CHAIR RETURN TIME	0.7 SEC
BROKEN BAG TIMEOUT	4.0 SEC
AFTER FILL VIBRATOR TIME	0.0 SEC
RETURN TO PREVIOUS MENU	

5.4.3.1 Refill Timer

Pneumatic packers (air packers) are typically equipped with a butterfly or slide gate valve located at the top of the filler's cylindrical "chamber". This valve separates the product supply bin from the "chamber", and when closed, allows the "chamber" to be pressurized to help convey the contents into the bag.

At the completion of each fill this butterfly or slide gate valve opens to re-charge the "chamber" and must remain open for a minimum time to allow enough product to flow from the bin into the "chamber". Different product types flow at different rates. Set this value to allow adequate time to re-charge before closing the valve.

If, for example, this value were set to ½ second, the valve would open, then close within ½ second and the next fill could begin. However, if this value were set to 10 seconds and the operator or placer placed another empty bag onto the filler, nothing would happen until the 10 second timer expired and the valve closed.

Using the Gross program to run an impeller packer takes advantage of all other settings except the refill timer. The typical impeller packer is not equipped with a valve or gate to open/close between fills. Set the refill timer to 0.0 for this type packer.

5.4.3.2 Blast Air

Certain types of products may become clogged within either the pinch tube or fill spout and not allow a fill to begin. Many types of air and impeller packers include or can be outfitted with an air fitting for connection of high-pressure air. The blast air timer turns on an output in the 5511 to dislodge the blockage, and is run at the beginning of every fill, just after opening the pinch tube. Typically this timer is set to ½ second or so.

5.4.3.3 Spout Purge

Some applications require a clean-out of the fill tube at the end of each fill to ensure that all product has transferred from the filler into the bag. Other applications may require this clean-out to limit product spillage after the bag is removed.

Spout purge time uses the same output as Blast Air Time, and runs at the end of the fill, after the pinch tube has been closed and before the bag is released and discharged.

5.4.3.4 Chair Return

Many air and impeller packers are equipped with a pneumatically operated bag chair. The bottom of the bag rests on the cheeks of this chair during the fill. At the end of the fill the chair assembly is actuated, removing the bag from the fill tube and discharging to a take-away conveyor or table.

Depending upon the style of chair, product, bag, air pressure and other variables, the time required to remove a bag varies. This timer sets the amount of time the output is energized to operate this device.

5.4.3.5 Broken Bag

One of the hazards of filling bags with an air or impeller packer is bag breakage. There are many reasons this happens, and it is impossible to avoid. An operator hand-placing bags knows immediately when a bag breaks, and stops the filling process before spilling too much product on the floor.

Automatically placed bags may typically have no one in attendance to catch this issue, so a timer is provided to assist with detecting broken bags. This timer value is set to the maximum allowable time required to properly fill a bag. If the timer is exceeded, the current fill is aborted and the bag clamp output is turned off, the bag chair kicks to discharge any remnants of the broken bag, and the fill cycle starts over at the beginning of the fill.

5.4.3.6 After Fill Vibrate

If the Vibrator Function is enabled, this timer can be set to provide additional compaction of the product in the bag once the fill is complete.

A typical fill sequence reaches weight, displays final weight, releases the bag clamp and actuates the bag chair to discharge the filled bag. Setting a time greater than 0.0 will hold the bag and actuate the vibrator once final weight is displayed. The vibrator will run up to 300 seconds, and then will release the bag clamp and actuate the bag chair.

5.4.4 Choosing Automatic or Manual Set Points

Depending upon the choice made in the configuration menu, the 5511/6611 controller may be set to operate in the Manual Set Point Mode, or the Auto Set Point Mode. Each mode affects the way that information is presented for entry of Target weight.

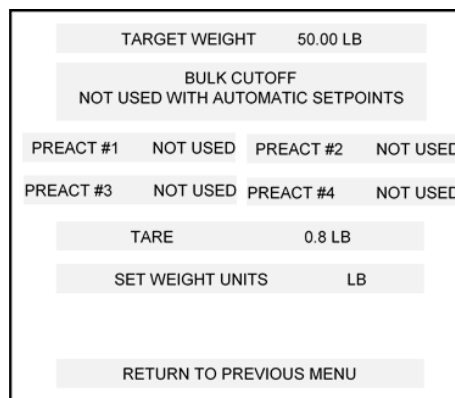

5.4.4.1 Automatic Set Point

The Automatic Set Point Mode requires entry of a Target Weight only, making internal calculations for proper cut-off and Pre Act values. Simply enter the Target weight and the controller will determine the most efficient bulk and dribble cut-off points.

5.4.4.2 Manual Set Point

Setting the Target Weight and the Bulk Cutoff point allows the user flexibility and control over exactly when the controller changes from Bulk to Dribble fill, and also presents variables for the Preact value. Preact is the amount of product in suspension from the instant the fill stops to the final weight taken by the filler controller. This value may be a negative value.

TARGET WEIGHT		50.00 LB	
BULK CUTOFF		29.50 LB	
PREACT #1	1.2 LB	PREACT #2	NOT USED
PREACT #3	NOT USED	PREACT #4	NOT USED
TARE		0.8 LB	
SET WEIGHT UNITS		LB	
RETURN TO PREVIOUS MENU			

The manual set point values are purely empirical and set based upon the user's real-time experience with a fill. Set the values low and fill a bag. Once the filler's performance is known the values can be adjusted to provide the best accuracies and final fill weight consistency, versus fill time. In this mode the operator is presented with a screen showing adjustments for the Preact value.

50.86		
0.00		
READY FIRST CYCLE		
Total Weight 0.00	Mean 0.00	Total Units 0
ZERO	TARE	
		DRIBBLE 33.8
		PREACT -0.21
		↑
		↑
		↓
		↓
MAIN MENU	RECIPE NUMBER 2	

The operator can quickly tap the screen to increase/decrease values for the Dribble cutoff point (if any) and the Preact value to achieve the best possible final fill weight accuracy. The values and adjustments are tracked and updated for the recipe.

5.5 Auger Filler

Like the air or impeller packer, this style filling machine is many times considered a Gross filler, with a horizontal fill spout and an auger that mechanically carries product into a bag, box or bucket. Special I/O considerations are made to control the auger and provide a quick and repeatable stop and reverse of the auger at the end of each fill.

Input #	Input Description	Output #	Output Description
1	Start Fill	1	Bulk Fill
2	Stop Fill	2	Dribble Fill
3	Bag In Place	3	Refill Valve
4	Not Used	4	Exhaust Valve
5	Not Used	5	Bag Clamp
6	Not Used	6	Chair Discharge
7	Not Used	7	Auger Reverse
8	Discharge Inhibit	8	Placer Interlock

Sequencing and screens, as shown above for the Gross Air/Impeller filler are the same, with the exception of the Set Timers screen within each recipe. This screen changes, eliminating blast air & spout purge timers, replacing them with Auger Reverse time:



5.6 Net Weigh Filler

A net weigh filler is defined as a bucket, bin or hopper suspended from load cells and filled from a feeder mechanism. Upon completion of a fill the bucket, bin or hopper discharges the load, as described by configuration settings in the 5511/6611 controller.

When the controller is configured as a net weigh filler controller, the following screen is displayed:

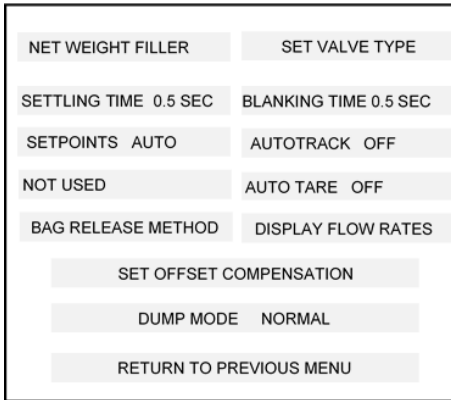

Description of the first 7 variables on this screen are described in sections 5.2, above. Items unique to the Net Weigh controller include Bag Release Method and Dump Mode.

5.6.1 Bag Release Method

Two methods for releasing a bag from the bag clamp; turn off the bag clamp output, or send a pulse to the bag hangar/robot controlling the bag clamp. The following screen offers these options:

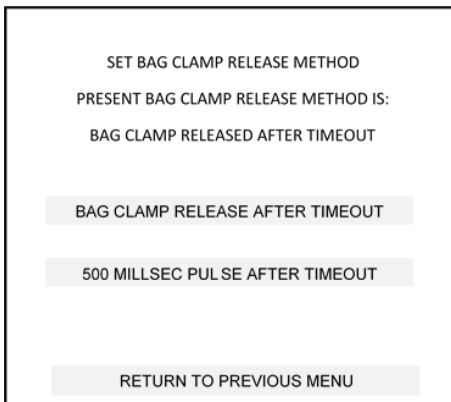

5.6.2 Dump Mode Options

Selecting Dump Mode will display the following screen:

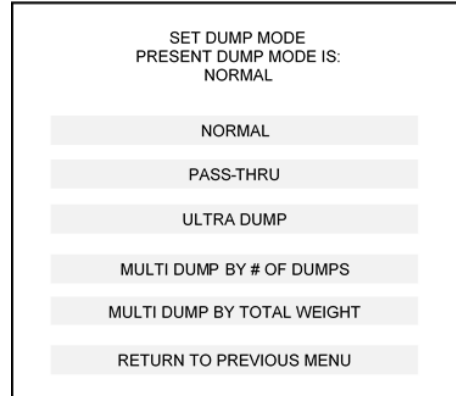

5.6.2.1 Normal Dump Mode

This mode looks for a bag in place signal and dumps the next appropriate net weigh bucket's contents to the bag, runs the bag clamp timer, then turns off the clamp to release the bag, then clamps a new bag in place for the next dump from the scales.

5.6.2.2 Pass-Thru Dump Mode

This mode is meant for applications where grains or other bulk materials are being transferred from one part of the process to another, and needs a net weigh scale to monitor weight of product being moved from one process to the other. No bag in place signal or interface is required. The scale fills to weight, dumps, closes the weigh bucket doors and fills again until the operator stops the filling process.

5.6.2.3 Ultra Dump

Some net weigh scales are arranged with side-by-side bag hangars and both bags must be filled at the same time. The Ultra Dump routine requires inputs from both bag clamps and will then discharge both weigh buckets at the same time.

5.6.2.4 Multi Dump by Count

Applications looking for a specific number of fills for a pallet or lot can use this feature. The filling process starts and the filler controller will run in the Normal Dump mode until it reaches the preset count. The filler controller will then stop and await operator input.

5.6.2.5 Multi Dump by Weight

As with Dump by Count, this feature fills and discharges until a preset weight value is achieved. If, for example, a net weigh filler is used to fill a bulk container to a value of 5,000 lbs., the 5511/6611 controller will fill successive fills and dumps until it reaches this set point. The filler program keeps track of weight and accumulated error, and will adjust the final fill weight for these errors so it can achieve the most accurate final fill weight closest to 5,000 lbs.

5.6.3 Net Weigh I/O and Sequencing

Input #	Input Description	Output #	Output Description
1	Start Fill	1	Bulk Fill
2	Stop Fill	2	Dribble Fill
3	Bag In Place	3	Hopper Doors Open
4	Hopper Door	4	Lower Test Wt.
5	Manual Dump	5	Bag Clamp
6	Foot Switch	6	
7	Jog	7	At Weight
8	Low Bin	8	Placer Interlock

Net Weigh Sequence of Operation (Normal Dump Mode):

- Operator starts fill from 5511 "Run" screen, or drive Input #1 ON momentarily for each scale
- Hopper doors closed input checked (if no sensor, wire to DC+ to drive input ON)
- Bulk/Dribble outputs energized, per user configuration of valve type
- Fill completes
- At any time during the fill "Bag In Place" input must come on and remain on
- Automatic bag hangar or foot switch input to provide "Bag In Place"
- At weight output generated
- Hopper Doors opened
- Hopper door discharge timer runs and Hopper door output de-energized when timer expires
- Hopper doors closed input checked, and next fill begins immediately
- Bag Clamp Release timer runs, allowing product fall from bucket to bag
- Bag Clamp output de-energized to release bag

Low Bin actuated will pause the fill process until more product is added to the intermediate bin above the filler

Some net weigh scales are equipped with test weights internal to the machinery. Output #4 will activate the test weight as part of the calibration procedure. Scales without this feature still display "lowering test weight" in the calibration procedure, but does not interfere with calibration.

5511 configured as a Duplex Net Weigh Scale controller will alternately dump the scales to ensure that if both scales come to weight simultaneously that preference is not given to one scale over the other.

5.6.4 Net Weigh Recipe Entry

Now that the filler configuration is complete a recipe must be created to set the Target weight and other variables unique to that recipe. Up to 100 recipes can be entered and quickly recalled.

From the Tools Menu, touch "Select/Edit Recipe"

ENTER NEW RECIPE

EDIT OLD RECIPE

RETURN TO PREVIOUS MENU

Entering a new recipe will assign the next sequential numbered recipe. You cannot select the recipe number to assign to a new recipe.

Selecting Edit Old Recipe will prompt the user to enter a number for a valid existing recipe. Once selected the following screen will appear:

EDIT RECIPE NUMBER 003

RECIPE NAME

RECIPE DESCRIPTION

EDIT WEIGHTS

NOT USED

SAVE RECIPE

RETURN TO PREVIOUS MENU

Select Edit Weights, and the following screen will appear:

TARGET WEIGHT	50.00 LB
BULK/DRIBBLE	B&D
HOPPER DISCHARGE TIME	0.5 SEC
BAG CLAMP RELEASE TIME	0.3 SEC
AUTO TRACK RESPONSE	5
NOT USED	
NOT USED	
RETURN TO PREVIOUS MENU	

5.6.4.1 Net Weigh Target Weight

Within the Filler Setup Menu the user can select Manual Set Points or Automatic Set Points. Automatic Set points only needs the target weight entered and will automatically calculate bulk cut-off point, dribble cut-off point and Pre Act values. Free-flowing and consistent product flow is well suited to Automatic set point mode.

Manual set point mode requires entry of the Target weight, bulk cut-off point and either positive or negative Pre Act for each scale.

TARGET WEIGHT		50.00 LB	
BULK CUTOFF NOT USED WITH AUTO SETPOINTS			
PREACT #1	NOT USED	PREACT #2	NOT USED
PREACT #3	NOT USED	PREACT #4	NOT USED
AUTO TRACK RESPONSE		5	
NOT USED			
NOT USED			
RETURN TO PREVIOUS MENU			

5.6.4.2 Hopper Discharge Time

This value sets the amount of time that the hopper discharge output is actuated, and should be set to allow all product to clear the weigh scale before allowing it to close again. Setting this value too short will result in off-weight bags due to trace amounts of product from the last fill still trapped within the weigh scale.

5.6.4.3 Bag Clamp Release Time

Typically a bag or box liner is held in a clamp mechanism, below the discharge point from the weigh scale. The start of the fill actuates the output for this clamp to hold the bag or liner in place. At the end of the fill a certain amount of time is required to get all the product discharged from the weigh scale into the container. This timer value holds the clamp actuated long enough to get all the product into the bag.

5.6.4.4 Auto Track Response

This is the number of fills used to make automatic weight corrections to the next fill. A default value of 5 averages the last 5 fills, then uses a portion of the error from those previous fills to adjust cut-off points for subsequent fills. Reducing this value makes the correction more responsive, but is more susceptible to over correction. Increasing this value results in a lower slower response to changes or errors.

5.6.5 Net Weigh Run Screen

The Run screen displays current fill weight, the final weight of each scale and prompts for the operator to change from one recipe to another, adjust set points, if used, and to start and stop the fill process.

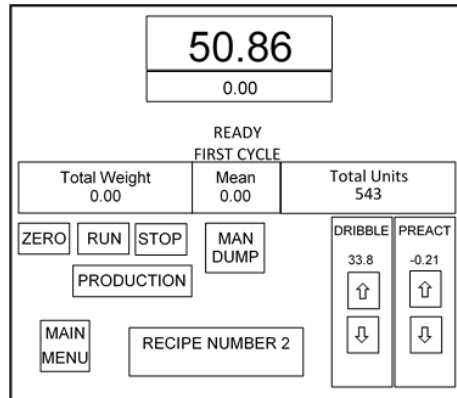

The filler will only operate when in this screen. To start the fill process, press the “Run” button.

The filler controller starts the fill process, finishes and discharges the filled weigh bucket, then automatically starts the next fill. This continues until the operator presses the “Stop” button, or leaves the screen back to the main menu. In either case the current fill will complete and discharge, then sit idle until the operator restarts the process.

For a duplex, 3 or 4 weigh bucket net weigh scale the screen for starting and stopping production is accessed by pressing the “Production” button on the main fill screen.

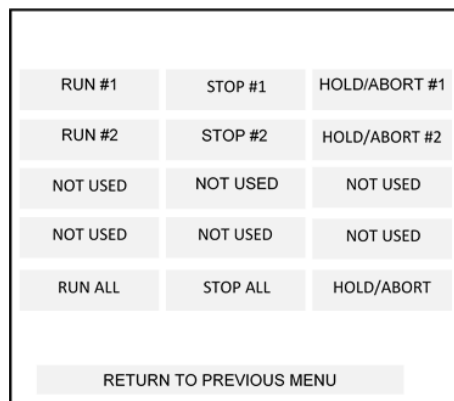

Pressing “Run” for any active scale will start the fill process. Pressing “Stop” for any active scale will bring the current fill to completion, discharge and go idle. Pressing “Hold/Abort” for any active scale will immediate stop the filling process and hold the product in the weigh bucket. If the operator presses this button again the fill will be aborted and discharged, if a bag is in place.

The Hold/Abort function is useful for situations where the supply bin runs empty and the operator needs to suspend the fill until more product is delivered to the supply bin, or when emptying out the supply bin and there is less than a full weigh bucket of product left.

5.7 Bulk Bag Filler Controls

This configuration of the 5511/6611 controller is intended for filling a Flexible Intermediate Bulk Container or bulk bag. This style bag may include loops for suspending the bag during the fill process, as well as a circular “neck” or opening used to fill the container.

Section 5.1 describes how to access and select the filler type. Once Bulk Bag Filler is selected the following configuration screen will appear:

BULK BAG FILLER	SET VALVE TYPE
SETTLING TIME 0.5 SEC	BLANKING TIME 0.5 SEC
SETPOINTS AUTO	AUTOTRACK OFF
INFLATE TIME 1.0 SEC	AUTO TARE OFF
DISPLAY FLOW RATES	
SET OFFSET COMPENSATION	
ENABLE-DISABLE FILLER FUNCTIONS	
RETURN TO PREVIOUS MENU	

Many of the items in this screen are described in section 5.2 of this chapter. Items unique to the bulk bag filler include Inflate time and Filler Functions.

5.7.1 Bulk Bag Inflate Time

Inflation time is a value used to actuate a blower to inflate the bulk bag or bag liner to eliminate product filling on a partially collapsed bag. This timer value will be dependent upon bag size, flow rate of the blower and other variables specific to the application. Set this value to ensure the bag is fully deployed, but not to the extent that pressure within the bag exerts too much pressure upon the scale.

5.7.2 Enable-Disable Filler Functions

Multiple options for peripheral devices on the bulk bag filler are set to be enabled or disabled, based upon the equipment. The following screen appears when this item is selected:

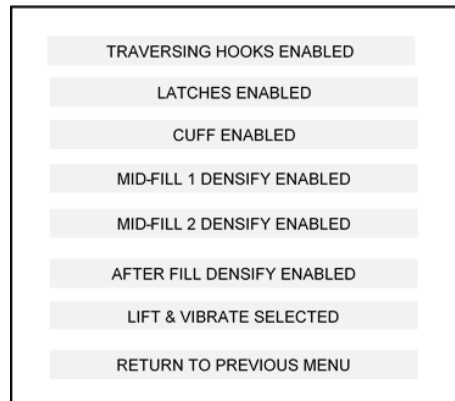

5.7.2.1 Traversing Hooks Function

Some bulk bag equipment offers latches for holding the loops of the bulk bag in place during the fill. Other types offer these latches with a pneumatic or electrical actuator that brings the furthest set of latches forward towards the operator, making insertion of the latches easier. If your bulk bagger has this feature you can enable its use with this controller function, otherwise select Disable.

Actuating the 5511/6611 controller input to use the traversing hooks is monitored. Actuating once tells the controller the latches are forward, towards the operator. Actuating a 2nd time confirms the latches have retracted to the position needed for filling the bag.

5.7.2.2 Latches Function

This function actuates an output to release the latches holding the bag loops on the hooks. In the deactuated position the latches are engaged to hold the bag loops in place. Disable this function if not used.

5.7.2.3 Cuff Function

The fill opening of the bulk bag can be placed around a fill spout with either a bladder that inflates to hold the neck in place, or a pneumatically operated clamp that actuates to hold the neck from the outside of the fill spout. If this function is enabled the controller will look for the "Cuff in place" input to go on, indicating that the cuff is secure on the fill spout. If the filling machine has only a mechanical clamp; bunge cord, strap, or hand clamp, disable this function.

5.7.2.4 Mid Fill 1 Densify Function

If the filling equipment includes a settler (see 5.7.2.7, below) then the operator can set the first of 2 densifying cycles to take place during the fill. When enabled the recipe will contain settings for a starting weight and duration of the densifying time.

5.7.2.5 Mid Fill 2 Densify Function

The second densifying cycle can be used to further settle product in the bulk bag, but caution should be used as to when this cycle will start and end. Do not set the values too close to the Target weight as it may interfere with calculating or detecting a setpoint value prior to the end of the fill.

5.7.2.6 After Fill Densify Function

If after fill densify is enabled the user must enter a time value for densification after the fill is complete. This timer must expire before the operator can disengage latches and cuff to remove the bag from the fill station.

5.7.2.7 Settling Method Function

Two methods are provided for densifying product within the bulk bag, with the proper method based upon the machine and the product characteristics.

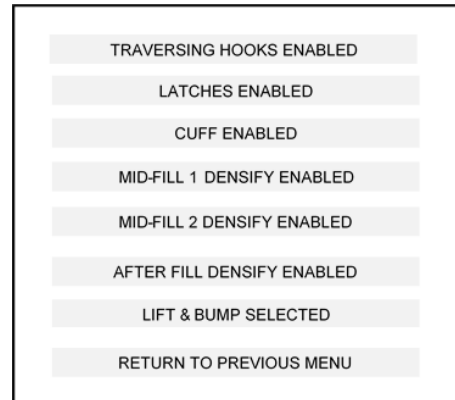
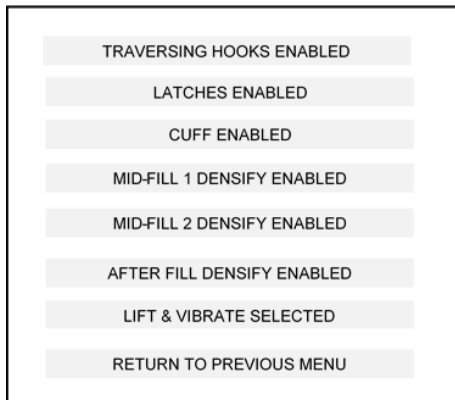

Lift & Vibrate settling method is for systems with a high frequency air or electrically actuated vibrator attached to the bulk bag station frame or conveyor. Typically these systems require the scale to be physically separated from the frame or conveyor to isolate the scale from the intense vibration. Two timers; one for raise time to separate the scale and frame/conveyor, and another for lower time to get the frame/conveyor back onto the scale. A separate timer sets the amount of time to vibrate when in the up position. This style densifier works best for large divided products, like granular or pellet type products.

Lift & Bump settling method typically uses air bags (air biscuits) to raise the frame/platform/conveyor then quickly lowering to create a low-frequency shaking action to settle product into the bag. The recipe will present two variables, and inflate time and deflate time. Depending upon air flow/exhaust from the air bags a longer inflate time than deflate time will result in a gentle bobbing up and down action. A longer deflate time than inflate time may result in the frame/platform/conveyor banging against the fixed part of the fill station. This method works well for finely divided products like flour and cement.

5.7.3 Bulk Bag I/O and Sequencing

Input #	Input Description	Output #	Output Description
1	Start Fill	1	Bulk Fill
2	Stop Fill	2	Dribble Fill
3	Traversing Hooks	3	Traversing Hooks
4	Cuff On/Off	4	Cuff Inflate/Clamp
5	Cuff In Place	5	Blower/Inflate
6	Latches Release	6	Latches Release
7		7	Vibrator
8		8	Lift or Lift/Bump

Bulk Bag Sequence of Operation (All Functions Enabled):

Fill station is empty. Pushbuttons are by others

- Operator presses "Hooks" pushbutton to bring hooks forward (traversing hooks forward)
- Operator places bag loops on hooks
- Operator presses "Hooks" pushbutton to send hooks back
- Operator places neck of bag on fill spout, presses "Cuff" pushbutton to inflate/deflate cuff or clamp
- Operator presses "Start" button
- 5511 turns on Blower/Inflate output for time set in recipe to inflate the bag
- Settling time is run
- TARE of bag and pallet, if any are taken
- Bulk fill gate opens and fills to first preset Densify 1
- Lift output actuated, timer for lift expires, and vibrator is turned on for time set in recipe
- Lift output deactuated, timer for lower expires and weight display becomes live again
- 2nd Densify cycle takes place
- Fill goes to Dribble fill, if any
- Fill complete, and gate shuts
- After fill Densify is run
- Settling time is run and expires
- Final Gross weight is displayed
- Operator presses "Cuff" pushbutton to deflate and release fill neck. Ties off neck
- Operator presses "Latches" button to release hooks

There are many variations of bulk bag fill stations, from very primitive and simple to complex. Enabling and disabling functions should fit the 5511/6611 controller well to nearly all bulk bag systems.

5.7.4 Bulk Bag Recipe Entry

From the Tools Menu, touch "Select/Edit Recipe"

A screenshot of a menu with three buttons. The top button is labeled "ENTER NEW RECIPE", the middle button is labeled "EDIT OLD RECIPE", and the bottom button is labeled "RETURN TO PREVIOUS MENU".

Entering a new recipe will assign the next sequential numbered recipe. You cannot select the recipe number to assign to a new recipe.

Selecting Edit Old Recipe will prompt the user to enter a number for a valid existing recipe. Once selected the following screen will appear:

A screenshot of a screen titled "EDIT RECIPE NUMBER 003". It contains several buttons: "RECIPE NAME", "RECIPE DESCRIPTION", "EDIT WEIGHTS", "NOT USED", "SAVE RECIPE", and "RETURN TO PREVIOUS MENU".

Select Edit Weights, and the following screen will appear:

A screenshot of a screen with several settings. Each setting is on a separate line with a label on the left and a value on the right. The settings are: "TARGET WEIGHT" (2000 LB), "BULK/DRIBBLE" (B&D), "LIFT & BUMP TIMERS" (no value), "MID-FILL 1 DENSIFY" (ON), "MID-FILL 2 DENSIFY" (OFF), "AFTER FILL DENSIFY" (OFF), "AUTO TRACK RESPONSE" (5), and "RETURN TO PREVIOUS MENU".

Set timers for Lift & Bump, or Lift & Vibrate

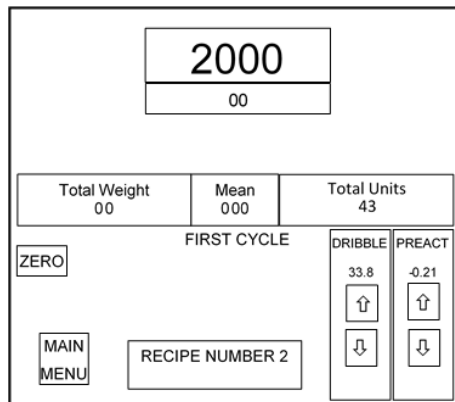

Bulk Bag Run Screen with Manual Set points

Inputs for Start, Stop, Cuff, Latch and Hook are created through external switches wired to the 5511/6611 inputs. These switches are provided by others, or can be purchased from Thompson Scale Co as an integrated filler controller enclosure or separate pushbutton station.

5.8 Top Off Filler

This style program is used in conjunction with any open-mouth filling system; box, bag-in-box, net weigh scale, etc. and is used as the secondary filling station for topping off to a precise final weight. For example, one application for this program has an open-mouth bag filling system quickly filling a bag of flour to 25 kg. and is based upon a time fill. A percentage of bags discharged from this filler are under-weight and move to the top off filler station where the 5511/6611 controller dispenses a small amount of product, about 1 kg or lower, into the bag to ensure it is on-weight.

The process for topping off the to the final weight typically takes less time than the main filler needs to do the initial fill. This keeps the top off fill station from becoming a bottle neck in the production line, and also eliminates the need for a check weigh scale further down the production line.

5.8.1 Top Off Filler I/O and Sequencing

Input #	Input Description	Output #	Output Description
1	Start Fill	1	Bulk Fill
2	Stop Fill	2	Dribble Fill
3	Package in Place	3	Filling
4		4	
5		5	
6		6	No Flow Alarm
7		7	Over-Weight Alarm
8		8	Fill Complete

Top Off Filler Sequence of Operation

- Up-stream filling system dispenses empty bag
- Customer’s conveyor controls monitor position of bag to Top Off Fill station, stop package
- Input #3 “Package in Place” driven on
- Gross weight of package detected and compared to current recipe Target weight and reject limits
- Bulk and or Dribble fill initiate to top off the package
- “Filling” output generated as status indicator to customer
- A “No Flow” alarm will be actuated if product is not being dispensed to the package within a specified time period
- If package final weight is outside of upper tolerance set in the recipe an Over-Weight alarm is generated
- If fill is successful and ready for discharge a “Fill Complete” is generated
- Fill Complete remains on until the 5511/6611 receives the “Packaging in Place” input

TARGET WEIGHT	50.00 LB
BULK/DRIBBLE	B&D
AUTO TRACK RESPONSE	5
HIGH REJECT	50.25 LB
LOW REJECT	49.95 LB
NOT USED	
NOT USED	
RETURN TO PREVIOUS MENU	

5.9 DWM IV Emulation Mode

The 5511 can be configured, via a hardware jumper, to emulate the Flex-Weigh® DWM IV Gross fill program. This program contains the identical outputs used by the DWM IV:

- Bulk
- Dribble
- Filling status
- Fill Complete
- Zero Lockout status
- Discharge

5.9.1 DWM Mode Recipe

Recipe set up is not found through the TOOLS icon on the Main Page, but from within the RUN icon. A button for "Recipe" is located below center, left, and leads to the following screen:

TARGET WEIGHT	50.00 LB
DRIBBLE (BULK SETPOINT)	43.79 LB
PRACT	0.98 LB
AUTO TARE ENABLED	
BULK/DRIBBLE	B&O
TIMERS	
WEIGHT UNITS	LB
ZERO LOCKOUT WEIGHT	0.22 LB
RETURN TO PREVIOUS MENU	

If Bulk-Only fill is selected, the Dribble (bulk set point) value will not display. Selecting "Timers" leads to the following screen:

DISCHARGE TIME	0.7 SEC
BLANKING TIME	1.2 SEC
SETTLING TIME	0.3 SEC
FILL COMPLETE TIME	1.4 SEC
RETURN TO PREVIOUS MENU	

5.9.1.1 Discharge Time

Discharge Time is an output used for operation of a pusher, bag chair or similar device used to remove a filled container from the system.

5.9.1.2 Blanking Time

Blanking Time is used in some applications for net weigh scales, bulk bag and box fillers, where there is a significant "bounce" imparted into the scale when the material stream changes from Bulk to Dribble. This bounce may be significant enough that the 5511 controller falsely detects an over-weight error and aborts the fill. Setting blanking time during this transition time will suppress weight readings from the filler controller's program, and allow for a smooth transition from Bulk to Dribble feed. This timer is a default value of 0.0 second. The timer can be set in increments of 0.1 second, up to a maximum of 5.0 seconds

5.9.1.3 Settling Time

Settling Time is invoked at both the beginning and the end of each fill. Once the filler machine is ready to begin filling, a timer is run to allow the filler and its mechanisms to come to rest before the filler controller takes a TARE. Once the timer expires, the 5511 takes the next scale reading as a reference, and zeros the filler. This TARE is stored and used only for this particular fill. This is done since air, auger, and impeller packers, and bulk bag & box fillers may have variations in the empty container weight for each fill.

When the fill is complete, the Settling Time is invoked again, finding a stable scale reading and using it as the final "checked" weight of the fill. TARE, stored at the beginning of the fill is subtracted, and a final Net weight is displayed before discharge of the filled container.

Settling time is set to 1.0 second as a default. Since many machines may settle much faster than 1 second, a variable is provided to allow adjustment from 0.1 to 5.0 seconds.

5.9.1.4 Fill Complete Time

This is the duration of time that the "Fill complete" output is energized at the end of the fill.

5.9.1.5 Zero Lockout Time

This drives ON output #7 on the Scale-I/O board as long as the weight on the scale is below the value entered for Zero Lockout Weight.

Once weight reaches the value and is equal to or greater than the Zero Lockout Weight, the output will be de-energized.

After timers are set and the recipe is complete, pressing the "Return to Previous Menu" button at the bottom of the screen will lead the user back to the RUN screen, shown below:

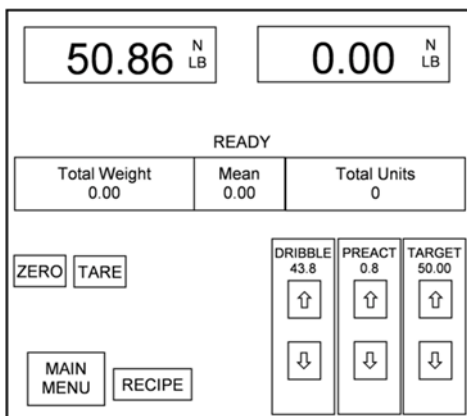

Prompts are provided for adjustment of the Target Weight, Dribble (Bulk Set Point) and Pre-Act. Double displays show live zero and the final weight of the last fill or real-time progress of the current fill.

5.10 Bulk Box Filler

This style fill program is intended for filling open-mouth containers that may include a liner to minimize spillage or dusting during the fill process, and may operate in an automated mode with containers entering the fill station, complete the fill process, then automatically move to the next step in the process.

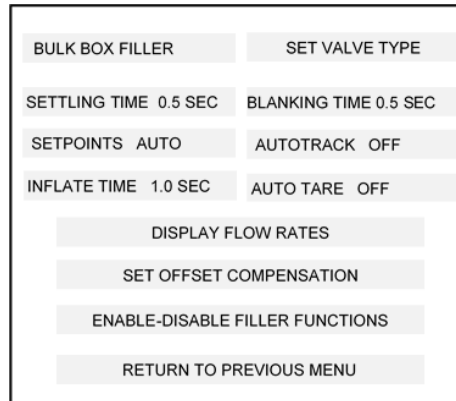

Items in the top half of this display are described in section 5.2 of this Chapter.

5.10.1 Enable-Disable Filler Functions

Multiple options for peripheral devices on the bulk bag filler are set to be enabled or disabled, based upon the equipment. The following screen appears when this item is selected:



5.10.1.1 Cuff Function

The container may include a liner that must be held to the fill spout before the fill process can begin. This output function holds the liner in place on the outside of the fill spout. If this function is enabled the controller will look for the "Liner in place" input to go on, indicating that the liner is secure on the fill spout. If the filling machine does not use a liner, disable this function.

5.10.1.2 Mid Fill 1 Densify Function

If the filling equipment includes a settler (see 5.10.1.5, below) then the operator can set the first of 2 densifying cycles to take place during the fill. When enabled the recipe will contain settings for a starting weight and duration of the densifying time.

5.10.1.3 Mid Fill 2 Densify Function

The second densifying cycle can be used to further settle product in the container, but caution should be used as to when this cycle will start and end. Do not set the values too close to the Target weight as it may interfere with calculating or detecting a setpoint value prior to the end of the fill.

5.10.1.4 After Fill Densify Function

If after fill densify is enabled the user must enter a time value for densification after the fill is complete. This timer must expire before the operator can disengage the liner clamp and remove the container from the fill station.

5.10.1.5 Settling Method Function

Two methods are provided for densifying product within the container, with the proper method based upon the machine and the product characteristics.

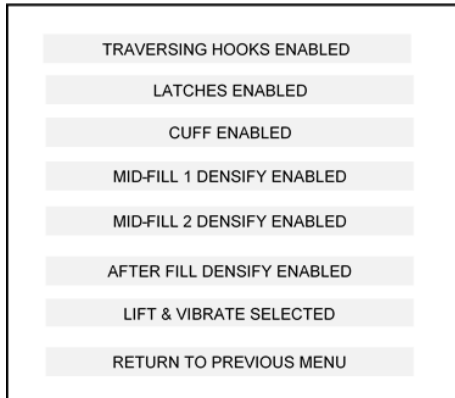

Lift & Vibrate settling method is for systems with a high frequency air or electrically actuated vibrator attached to the fill station frame or conveyor. Typically these systems require the scale to be physically separated from the frame or conveyor to isolate the scale from the intense vibration. Two timers; one for raise time to separate the scale and frame/conveyor, and another for lower time to get the frame/conveyor back onto the scale. A separate timer sets the amount of time to vibrate when in the up position. This style densifier works best for large divided products, like granular or pellet type products.

Lift & Bump settling method typically uses air bags (air biscuits) to raise the frame/platform/conveyor then quickly lowering to create a low-frequency shaking action to settle product into the bag. The recipe will present two variables, and inflate time and deflate time. Depending upon air flow/exhaust from the air bags a longer inflate time than deflate time will result in a gentle bobbing up and down action. A longer deflate time than inflate time may result in the frame/platform/conveyor banging against the fixed part of the fill station. This method works well for finely divided products like flour and cement.

5.10.2 Bulk Bag I/O and Sequencing

Input #	Input Description	Output #	Output Description
1	Start Fill	1	Bulk Fill
2	Stop Fill	2	Dribble Fill
3	Box in Place	3	Filling
4	Cuff On/Off	4	Cuff Inflate/Clamp
5	Cuff In Place	5	Blower/Inflate
6	Discharge	6	Vibrator
7		7	Lift or Lift/Bump
8		8	Fill Complete

Bulk Bag Sequence of Operation (All Functions Enabled):

Fill station is empty. Pushbuttons are by others

- Operator places liner on fill spout, presses "Cuff" pushbutton to clamp the liner
- Operator presses "Start" button
- 5511 turns on Blower/Inflate output for time set in recipe to inflate the liner
- Settling time is run
- TARE of container and pallet, if any, are taken
- Bulk fill gate opens and fills to first preset Density 1
- Lift output actuated, timer for lift expires, and vibrator is turned on for time set in recipe
- Lift output deactuated, timer for lower expires and weight display becomes live again
- 2nd Density cycle takes place
- Fill goes to Dribble fill, if any
- Fill complete, and gate shuts
- After fill Density is run
- Settling time is run and expires
- Final Net weight is displayed. Serial and Ethernet ports transmit Gross/Net/TARE, container count
- Operator presses "Cuff" pushbutton to release the liner
- Operator presses "Discharge" pushbutton to generate "Fill Complete" output

Applications without a liner will set the Inflate timer to 0.00.

If the liner function is disabled the fill will complete, Final weight will be displayed and the "Fill Complete" output will be energized.

TARGET WEIGHT	2000 LB
BULK/DRIBBLE	B&D
LIFT & BUMP TIMERS	
MID-FILL 1 DENSIFY	ON
MID-FILL 2 DENSIFY	OFF
AFTER FILL DENSIFY	OFF
AUTO TRACK RESPONSE	5
RETURN TO PREVIOUS MENU	

Set timers for Lift & Bump, or Lift & Vibrate

INFLATE TIME	2.2 SEC
DEFLATE TIME	2.0 SEC
RETURN TO PREVIOUS MENU	

5.11 Liquid Container Filler

This program differs from other filler types by providing a sequence to lower a fill lance into a container, then slowly raise the lance during the fill in an attempt to keep only the tip of the lance submerged in the liquid. This reduces splash and foaming as liquids are filled into the container.

5.11.1 Liquid Fill I/O and Sequence

Input #	Input Description	Output #	Output Description
1	Start Fill	1	Bulk Fill
2	Stop Fill	2	Dribble Fill
3	Container in Place	3	Filling
4	Lance "Home"	4	Lance Up
5	Lance "Extended"	5	Lance Down
6	Lance "Top"	6	Pump
7		7	
8		8	Fill Complete

Sequence of operation

- With the controller on and the filler at rest, it is expected that the fill lance will be at the "home" position, fully retracted. The "home" sensor drives Input #4 ON.
- A container is moved in place, actuating a sensor or causing the 5511 Input #3 "Container In Place" to be driven ON.
- Start Input is actuated, as either a pulse or can be on throughout the fill. The 5511 actuates Output #5 "Lance Down", until Input #5 "Lance Extended" is turned ON. When this input is driven on the Output #5 is deactuated.
- Output #6 "Pump" is turned on
- Output #1 "Bulk" is turned on
- The lance is raised in 10 steps from the "Lance Extended" position to the Input #6 "Lance Stroke Limit" sensor that defines the highest position the lance can go and still be within the container.
- The value of time for each of these 10 steps is defined within each product recipe and is user-defined.
- If the value is too large to complete all 10 steps during the fill the lance will stop once it reaches the "Lance Stroke Limit" sensor, keeping the lance within the container and allowing the fill to complete without product spillage.
- The fill runs through Bulk and Dribble (if used) positions, and upon completion of the fill the pump is turned off. The lance is retracted to the "Home" position, and the "Fill Complete" output is turned on, indicating the filler is ready for the next container.

5.12 Weightless Filler

This program is intended for use with a Gross Filler (valve bagger) system that uses a counter-balance or other non electronic method of reaching a fill weight. This routine does not monitor the load cell connection on the scale & I/O boards, and relies upon two simple inputs to start and stop the fill.

When this mode is selected there is only "Tools" and "Run" icons on the main screen. Entering "Tools" displays:

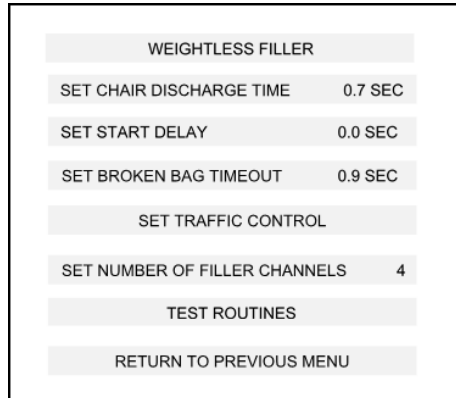

The Run screen displays a box for each channel, containing a fill time in hundredths of a second (0.00), displayed to provide the operator with feedback on performance of each fill spout. This value can be used to tune the filler to run at the fastest and most efficient fill rate, and to detect problems that may occur with a fill spout. If other fill spouts run at around 3.30 seconds per fill, but one runs at 5.20 seconds, there is most likely a blockage, or air flow is being restricted.

Below the time boxes are totals and units per minute. Units per minute is averaged over a 60 second time period. When filling begins this value will remain unchanged until the first minute of production has passed, and will then update to show fills per minute.

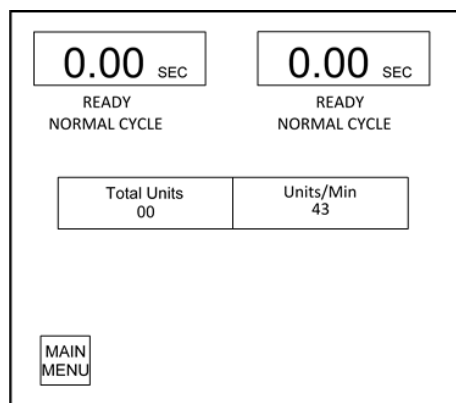

5.12.1 Weightless Fill I/O and Sequence

Input #	Input Description	Output #	Output Description
1	Start Fill	1	Bulk Fill
2	Fill Finish/Abort	2	Not used
3	Bag In Place	3	Refill Valve
4	Not Used	4	Exhaust Valve
5	Not Used	5	Bag Clamp
6	Not Used	6	Chair Discharge
7	Not Used	7	Not used
8	Discharge Inhibit	8	Placer Interlock

Sequence of operation

A start input from either a pushbutton, limit switch or proximity sensor begins the fill sequence:

- Bag Clamp Output turned on to hold the bag on the fill spout
- Bulk Feedgate actuated to begin the fill, and may be paralleled with an actuator for turning on the low pressure air supply to the filler
- NO dribble feed is available
- Stop input from either the operator pushing an "abort" button, or an at-weight sensor that is triggered by the counter-balance or trip mechanism.
- Bulk Feedgate is closed
- Bag clamp released
- Bag chair actuated to kick the bag from the filler
- Traffic Control for a 2, 3 or 4-spout filler can be used to control bag discharge. See Section 5.4.1 for details

Chapter 6

Data Settings



WARNING: CHANGES TO CONFIGURATION MAY AFFECT PERFORMANCE AND OPERATION OF THE SCALE CONTROLLER, AND MAY YIELD UNDESIRE RESULTS.

READ AND UNDERSTAND SETTINGS BEFORE MAKING CHANGES

Thompson Scale Co. offers two models of controller; 5511 and 6611. Both run the same programs and offer the same user interface screens and many of the same features. The 5511 offers a smaller motherboard, containing a serial port dedicated to the transmission of weight and production date. A second serial port is dedicated to interfacing with the touch screen HMI, and a third port is dedicated to interfacing with the optional EIP protocol converter, described in section 6.4, below.

The 6611 motherboard offers 2 additional serial ports for transmission of weight and production data. As with the 5511, all ports can be configured RS-232 or RS-422.

From the main screen, select the Tools Icon:

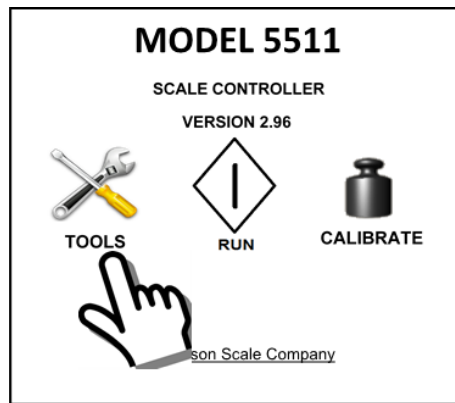

Select Data Settings Button:

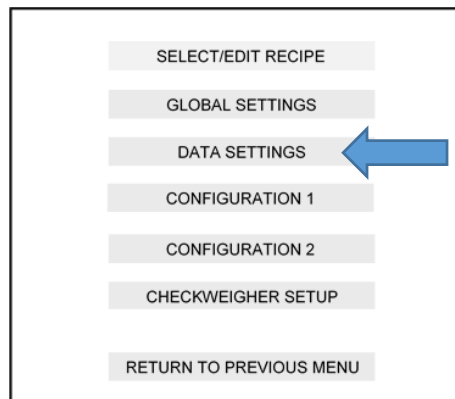

The following screen will appear:

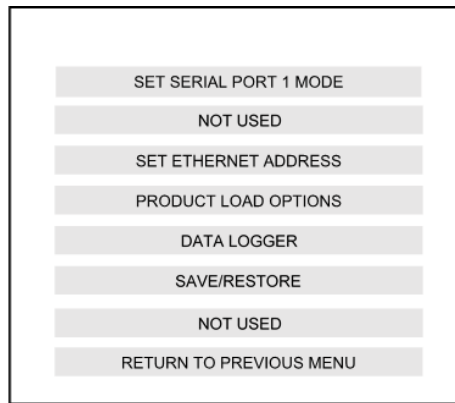

6.1 Set Serial Port 1 Mode

Entering into this menu choice reveals the following screen:

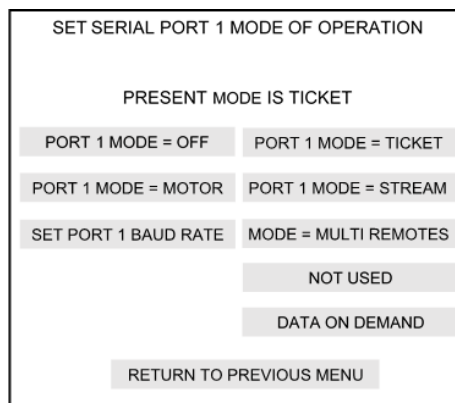

6.1.1 Set Serial Port 1 Mode - Off

Occasions may arise where the port may need to be disabled to allow for troubleshooting or to stop transmission of any data from the scale. Selecting this mode will change the 2nd line of this display to "PRESENT MODE IS OFF"

6.1.2 Set Serial Port 1 Mode to Ticket

Selecting this mode will cause weight data to transmit one (1) time at the completion of a fill or as weight is terminated on the checkweigher. Multiple data can be transmitted in this mode, including actual weight, target, TARE weight, reject limits and pass/fail information.

The port will, at a minimum, transmit:

<STX><ID><SPACE or – Sign><7 Digits, Leading Zeros Suppressed><CR><LF><ETX>

A checked weight of 3.982 lb would transmit as:

<STX><A><Space>< 3.982><CR><LF><ETX>

STX is an ASCII command for start of text

ID is an ASCII value from A to D, and represents the scale board and position. If two scale-I/O boards are in the 5511, one will cause transmission of the "A", while the other will transmit "B" as a prefix to each weight.

The space or minus sign (-)

Weight data in 7 digits, leading zeros suppressed

CR is an ASCII command for carriage return

LF is an ASCII command for line feed

ETX is an ASCII command for end of text

Other data can be enabled, and will always place in the same position in the string:

- STX
- ID
- Last Weight,
- Target Weight,
- High Reject,
- Low Reject,
- TARE Weight,
- Pass or Fail,
- Date (as MM:DD:YY),
- Time (as HH:MM:SS),
- Total Units,
- CR
- LF
- ETX

Target weight, high reject, low reject and TARE are data entered as part of the recipe for a checkweigher. Filling systems typically only have Target weight.

Pass or Fail are transmitted as the complete word "PASS" or "FAIL", and are available for checkweighers and some limited types of filling systems

The screen presented for configuration of this data output has buttons for each of the 8 variables. Touch one of the buttons and the status will change from "DISABLED" to "ENABLED"

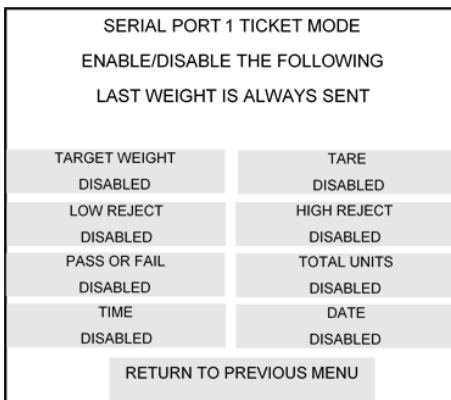

6.1.3 Set Serial Port 1 Mode to Stream

This method is meant for transmission of continuous weight data to a device, such as a remote digital display. Only the current or last held weight value is transmitted.

6.1.4 Set Serial Port 1 Mode to Motor

When the 5511/6611 controller is used in conjunction with certain configurations of Thompson Scale's Sonic 350 Checkweigher this port can be configured to transmit commands formatted specifically for the operation of servo motors used to drive the miniature conveyors of the Sonic 350 Checkweigher. This does not apply to the Sonic 350SHD or Sonic 350MDR models.

6.1.5 Set Port 1 Baud Rate

The default Baud is 1,200. Other transmission rates are available, and can be selected from the following menu:

SET SERIAL PORT 1 BAUD RATE	
PRESENT BAUDE RATE IS: 9600 BAUD	
SET BAUD = 1200	SET BAUD = 19200
SET BAUD = 2400	SET BAUD = 38400
SET BAUD = 4800	SET BAUD = 57600
SET BAUD = 9600	SET BAUD = 115200
RETURN TO PREVIOUS MENU	

6.1.6 Set Serial Port 1 Mode = Multi Remotes

This mode transmits 4 specific sets of information to allow different production information to be shown on separate remote digital displays simultaneously. When this mode is selected the controller transmits out:

- "A" followed by the last package weight
- "B" followed by total count value for the production run
- "C" followed by total weight value for the production run
- "D" followed by average, as defined by the user.

If the controller is configured as a checkweigher, go to "Tools" menu, then "Configuration 2". Select "Average Weight Settings" and define how average is to be displayed.

6.1.7 Set Serial Port 1 Mode to Data On Demand

This feature is dedicated for use with the Checkweigher controller configuration. The last package weight value is held in memory, then transmitted when an ASCII "Ctrl U" is received on serial port #1. Upon receipt of this character the 5511/6611 controller will transmit the weight value one time.

The weight value will be overwritten if the command is not received before another weighment takes place on the checkweigher.

If the command is received and no new weight is in memory the port will transmit 0.00

6.2 Set Ethernet Address

The 5511/6611 contains a resident Ethernet TCP/IP port through which data can be exchanged. This port must be configured to become compatible with the installation site's network and settings. The following screen is displayed:

```

--IP SETTINGS--
CURRENT IP ADDRESS SETTINGS:
IP: 0.0.0.0
Mask 0.0.0.0
Gate: 0.0.0.0
DNS 0.0.0.0
  
```

The screenshot shows a menu titled "--IP SETTINGS--" with the heading "CURRENT IP ADDRESS SETTINGS:". Below this, the current settings are listed: IP: 0.0.0.0, Mask 0.0.0.0, Gate: 0.0.0.0, and DNS 0.0.0.0. There are four colored buttons: a grey "IP" button, a yellow "MASK" button, a green "GATE" button, and a yellow "DNS" button. At the bottom of the menu is a grey "RETURN TO PREVIOUS MENU" button.

Select each of the 4 boxes and enter a valid address. If, for example the address being entered is 255.0.255.255, then enter the string as follows:

255 then 0 then the Space bar, then 255, then 255

Do not press the decimal key nor Enter until the string is complete.

Contact the IT department at the installation site to determine the proper address for the 5511/6611 port.

6.3 Product Load Options

Thompson Scale Company offers a data logging and reporting software, called StatPak-PC II, that installs in the user's PC and collects weight data via an Ethernet TCP/IP connection.

StatPak-PC II stores all recipes; target, limits, recipe name, etc., within its database and recipe information is no longer stored in the non-volatile memory of the 5511/6611. If using StatPak-PC II, set to "Load Via StatPak-PC".

```

PRESENT LOAD MODE IS:
LOAD LOCALLY

LOAD LOCALLY
LOAD VIA STATPAK-PC

RETURN TO PREVIOUS MENU
  
```

The screenshot shows a menu titled "PRESENT LOAD MODE IS:" with the option "LOAD LOCALLY" displayed. Below this are three buttons: a grey "LOAD LOCALLY" button, a grey "LOAD VIA STATPAK-PC" button, and a grey "RETURN TO PREVIOUS MENU" button.

StatPak-PC II recipes are called by the operator when they press the "Recipe Number" button at the bottom of the Run screen. This sends a query to the StatPak-PC software and the following screen is displayed:

CLOSEST MATCHING MATERIAL FROM PC	
PRODUCT: AFG 50#	
HIGH REJECT	51.00 LB
HIGH PASS	50.50 LB
TARGET WEIGHT	50.00 LB
LOW PASS	49.50 LB
LOW REJECT	49.00 LB
TARE	0.60 LB
LOT #:	
SOURCE #	
LOAD MATERIAL TO RUN	
PREVIOUS MATERIAL	SERIAL EEPROMS
ENTER LOT #	ENTER SOURCE #
RETURN TO PREVIOUS MENU	

The operator begins typing the name of the recipe and the closest match will appear on screen. If it's not the correct match the operator can continue typing until the proper match appears. The operator will then select the match and the recipe parameters will be transmitted from StatPak-PC II to the controller and will load as the current recipe to run.

Advantages of this software and retaining recipes within the software's database is security and the ability to assign a lot and source number with each run. The operator cannot access any recipe information from the controller, so there is no opportunity to incorrectly enter or change information within a recipe. Recipe changes at the PC are tracked as well, with each change recorded and a new recipe version number assigned.

6.3.1 SPPC-Lite Data Logging Software

A lower-cost alternative to StatPak-PC II is SPPC-Lite. This software installs in the user's PC and captures weight data from the 5511/6611, configured in the "Load Locally" mode.

As the operator completes a production run; changes from one recipe to another or reloads the current recipe at the end of a shift or campaign, the 5511 will transmit a header string containing recipe name, target weight and reject limits, if used with the particular scale and settings. This header string triggers the software to close the file for the existing production run, and open a new file based upon parameters in the header string.

6.4 Data Logger

Thompson Scale offers the Model 930 Data Logger as an option for collecting and storing weight data from the 5511/6611 controller.

The 930 Data Logger connects to either serial Port #1 or Port #2 via a 5 conductor cable, typically provided with the data logger. This provides RS-232 bi-directional communications and a 5VDC power source to run the 930 Data Logger.

A 2GB USB thumb drive is included with the 930, and can store many days or weeks' worth of data. Please refer to the Model 930 Data Logger user's guide for information on use of this option.

6.5 Save/Restore Feature

Another feature of the Model 930 Data Logger is the ability to save or restore all configuration and recipe information from the 5511/6611 controller. Refer to the Model 930 Data Logger user's guide for information on use of this feature.

6.6 Remote Recipe Load

This feature provides bi-directional communication between the 5511/6611 and the user's PC, and uses a pre-defined set of ASCII commands to create, edit and load recipes from the user's software/programming product. This feature is

accessible via the Ethernet TCP/IP port or serial Port #2 on the 5511 motherboard or the serial Port #3 on the 6611 motherboard.

The 5511 controller can store 100 unique product recipes in memory. Remote product load must specify a product number to enter or edit between 001 and 100 any value outside of this range will cause an error response from the controller. Any product between 001 and 100 can be loaded in any order desired.

Each command is transmitted to the controller, and a response is generated back to the transmitting terminal with either an acknowledge (accept) or error code. Commands are structured with standard ASCII control codes surrounding the data sets:

STX<E00>CR LF ETX is issued as a data/command acknowledgement

STX<E01>CR LF ETX is issued as an error or non-valid command

Recipe Load Commands:

- 001 Load Recipe Name Field into temporary memory (max 40 characters)
- 002 Load Recipe Description Field into temporary memory (max 40 characters)
- 003 Load High Reject value into temporary memory
- 004 Load High Pass value into temporary memory (not used if configured as 3-zone checkweigher)
- 005 Load Target Weight value into temporary memory
- 006 Load Low Pass value into temporary memory (not used if configured as 3-zone checkweigher)
- 007 Load Low Reject value into temporary memory
- 008 Load TARE (container weight) value into temporary memory
- 009 Load Units into temporary memory
(00001 = lbs, 00002 = kg, 00003 = oz, 00004 = g)
- 010 Load these variables into Recipe "x"

Command 011 is invalid and will result in an error

- 012 Load an existing Recipe number to run as current recipe

This process loads each individual component of a checkweigher recipe into temporary memory, then a command is issued to load this group of values into a recipe location. This can be done while the checkweigher is currently in operation, running another recipe.

The next step in the process is to use command 012 to load a recipe as the current running recipe.

As an example, the following new recipe variables are to be transmitted to the 5511/6611 controller:

Recipe name =	Acme Red Widgets
Recipe Description =	1 lb. Round Small Widgets
High Reject =	1.20
High Pass =	1.10
Target Weight =	1.00
Low Pass =	0.99
Low Reject =	0.97
TARE =	0.01
Units =	lbs.

The ASCII transmission for this recipe would look like this (spaces included for clarity between control characters and data)

```
STX 001 Acme Red Widgets CR LF
      Response back of E00 from controller
STX 002 1 lb Round Small Widgets
      Response back of E00 from controller
STX 003 1.20 CR LF
      Response back of E00 from controller
STX 004 1.10 CR LF
      Response back of E00 from controller
STX 005 1.00 CR LF
      Response back of E00 from controller
STX 006 0.99 CR LF
      Response back of E00 from controller
STX 007 0.97 CR LF
      Response back of E00 from controller
STX 008 0.01 CR LF
      Response back of E00 from controller
STX 009 00001 CR LF
      Response back of E00 from controller
STX 010 004 CR LF
      Response back of E00 from controller
```

The recipe has now been created and loaded into recipe location 004

For this discussion we will assume the production line is in operation and the current recipe running is 001, small blue widgets. New recipes can be created and loaded into other recipe locations within the 5511/6611 controller without interrupting or changing the current running recipe.

When change-over from recipe 001 to another recipe is required this step can be done on the production line manually, or with the command 012.

```
STX 012 004 CR LF
      Response back of E00 from controller
```

Recipe 004 is now loaded as the current running recipe

6.7 Ethernet IP Option

The 5511 and 6611 Scale Controller's (5511) optional Ethernet IP interface (EIP) is used to exchange data between the 5511 and PLC's or other control devices using Allen Bradley's EIP network. While the 5511 and 6611 Scale Controllers' hardware are slightly different, the EIP interface is identical and is referred to as the 5511 throughout this document.

The EIP interface can also be used for remote control and configuration of the 5511, where a pre-defined set of variables are manipulated to control and modify operation of 5511.

Tools within this option allow the user to configure, calibrate, operate and display every variable within the 5511. This presents the opportunity to purchase only the motherboard, scale I/O card, and EIP module to create a totally custom look for your scale application.

There are two types of data exchange – process and configuration data.

Process data is exchanged synchronously and is setup and managed in the I/O configuration of the PLC. Details can be found in the Thompson Scale 5511 Scale Controller EIP Interface – Process Data section below.

Configuration Data is exchanged asynchronously and is managed through sets of message commands. These message commands either use the Get Attribute Single or Set Attribute Single services to read from or write to the 5511.

The wiring for this network is via Ethernet cabling – and this option's IP Address must be changed to match the local EIP network.

The following pages describe the process of reading and writing to the 5511's EIP interface, both to the Process and the Configuration Data.

6.5.1 EIP Interface – Process Data

The 5511 Scale Controller's process data provides current status information of I/O, scale, and control variables. The list of variables available are described in two user defined data types (UDTs). These UDTs are structures that match the layout of the process data produced and consumed by the 5511.

These UDTs are named TSC_5511_Input_Process_Data and TSC_5511_Output_Process_Data and multiple instances of this user defined data type can be used as needed.

In order to access this data – and to talk to the module at all, the module must first be setup in the I/O configuration of the PLC. See instructions below:

Step 1:

Add/create a new module – ETHERNET-MODULE (Generic Ethernet Module):

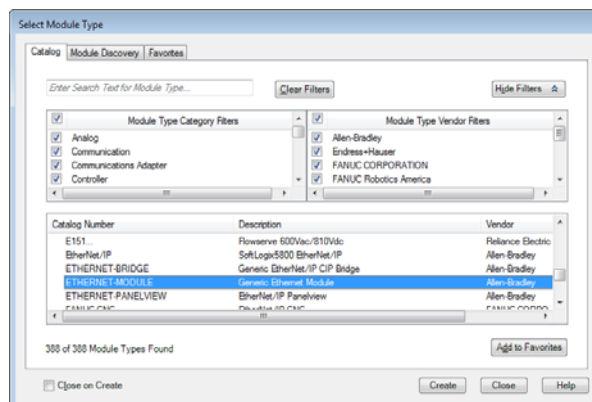

Step 2:

Name the module, add the IP Address, enter the connection parameters, and enter the RPI shown below:

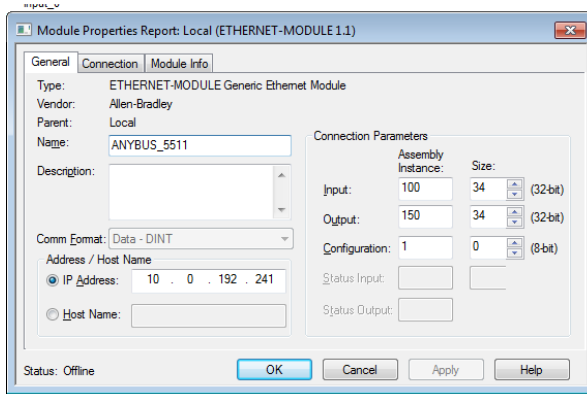

Step 3:

Now, the data can be accessed by simply copying the ANYBUS_5511 module data to PLC memory using the COP command:

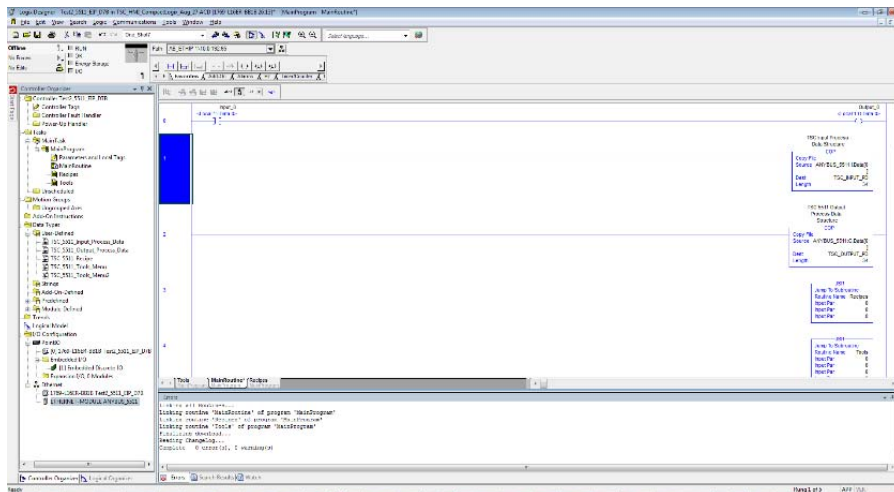
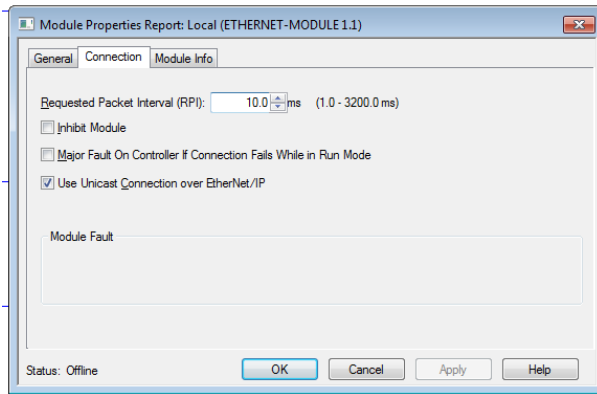

6.5.2 EIP Interface - Recipes

The 5511 Scale Controller's EIP interface can be used to process existing or create new recipes. When referring to recipes in this document, it is assumed that all recipes are located in the 5511 Scale Controller and the PLC merely reads from and writes to these recipes.

Processing of 5511 recipes through the EIP interface is facilitated through the use of a user defined data type (TSC_5511_Recipe). This user defined data type is in effect a structure that matches the layout of the recipes in the 5511 plus four control variables. This user defined data structure is named TSC_5511_Recipe and multiple instances of this user defined data type can be used as needed.

The recipe services available through the EIP interface are controlled by two (2) control variables, Control_100 and Control_101. Both of these variables are integers and are described below. The other two control variables (Control_102 and Control_103) are reserved for future use.

Control_100

There are 100 recipes in the 5511, so valid range for the Control_100 variable is 1 through 100. Any other value will not be allowed.

Control_101

Service request. There are four service request types, described in the table below.

Control_101 variable code	Control_101 variable service
0	<i>No service request</i>
1	<p><i>Save and Load Recipe:</i> This service allows the PLC to create/edit/modify a new or existing recipe and then save it in the 5511 and also load it to run. This service code is combined with service codes 4 and 8.</p> <p>The recipe number is in the Control_100 variable and must be pre-loaded before the service is requested.</p>
2	<p><i>Load Recipe:</i> This Service allows the PLC to select a recipe already saved in the 5511 to run.</p> <p>The recipe number is in the Control_100 variable and must be pre-loaded before the service is requested.</p>
4	<p><i>Read Recipe:</i> This Service allows the PLC to retrieve all parameters from an existing recipe (recipe number is in Control_100). This service code is used together with service code 1. That is, the PLC would first use service code 4 (or 8), then modify/edit the recipe parameters, and then use service code 1 to save and load any changes.</p> <p>The recipe number is in the Control_100 variable and must be pre-loaded before the service is requested.</p>
8	<p><i>Read Current Recipe:</i> This Service allows the PLC to retrieve all parameters from the recipe that is currently loaded in the 5511. This service code is used together with service code 1. That is, the PLC would first use service code 8 (or 4), then modify/edit the recipe parameters, and then use service code 1 to save and load any changes.</p> <p>The recipe number is in the Control_100 variable and must be pre-loaded before the service is requested.</p>

The procedure for processing recipe services in the 5511 is shown below. Review PLC program, in particular the Recipes routine for more details.

To Read a Recipe:

1. Set the value of Control_101 to 4 (Read Recipe number #x)
2. Set the value of Control_100 to desired recipe number (in this example, recipe #1)
3. Fill the Recipe_Prod_Desc_Array (length = 20 chars) with zeros
4. Fill the Recipe_Prod_Name_Array (length = 20 chars) with zeros
5. Fill the Recipe_Weights_Params_Array (length = 66 ints) with zeros
6. Now set the Read_Recipe_X_1 int to a value of 1.
7. The PLC sends a "Set Attribute Single" message indicating the type of service required (Control_101 = 4 = Read Recipe), along with a recipe number (Control_100 = 1 in this example).
8. The PLC then waits for the message's done bit to be set, indicating that the 5511 has processed the service request.
9. The PLC then sends a "Get Attribute Single" message, requesting the parameter values of the processed recipe. This step is optional is used to confirm the operating recipe has been modified accordingly.
10. The PLC then waits for this second message's done bit to be set, indicating that the recipe parameters have been read by the PLC. This step is optional is used to confirm the operating recipe has been modified accordingly.

EIP Details for Recipe Instance – Get Attribute messages:

Instance	=	Recipe
Instance number	=	74
Class	=	A2 (Hex)
Attribute	=	5 (Hex)
Destination Element	=	Recipe_READ_Data structure
Data length	=	208 bytes – data is mixed though

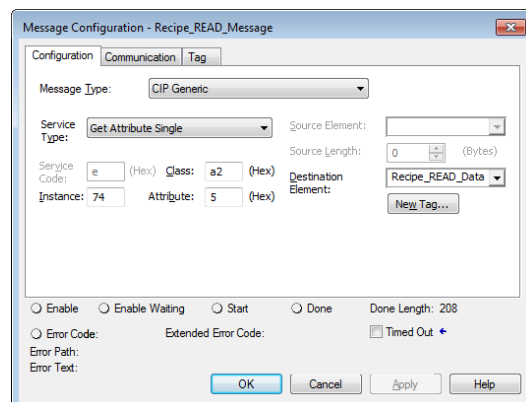

EIP Details for Recipe Instance – Set Attribute messages:

Instance = Recipe
 Instance number = 74
 Class = A2 (Hex)
 Attribute = 5 (Hex)
 Destination Element = Recipe_WRITE_Data structure
 Data length = 208 bytes – data is mixed though

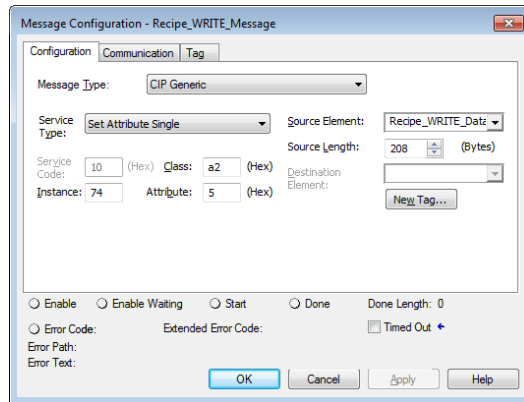
**6.5.3 EIP Interface – Tools Menu**

The 5511 Scale Controller's EIP interface can be used to process all configuration settings located in the 5511 Scale Controller. These settings are located in the Tools Menu and the PLC reads from and writes to these configuration variables. Due to the limits of the EIP interface, the Tools Menu variables are accessed from two (2) separate pages. In order to retrieve all variable values, read and write requests must be made to both pages – albeit one page at a time. Processing of Tools Menu variables through the EIP interface is facilitated through the use of two user defined data types (UDT) – one for each page of the Tools Menu. These UDTs are structures that match the layout of the two (2) pages of the Tools Menu variables in the 5511 plus two control variables for each page. These UDTs are named TSC_5511_Tools_Menu and TSC_5511_Tools_Menu2 and multiple instances of these user defined data types can be used as needed.

The instances used for the Tools Menu are described below:

- Tools_READ_Data (and Tools_READ_Data2) – used with the “Get Attribute Single” messages to retrieve current values of the 5511 Tools Menu. Once these instances are loaded, they are copied into the Tools_Array_for_HMI and Tools_array_for_HMI2 arrays so the values can be edited.
- Tools_WRITE_Data (and Tools_WRITE_Data2) – used with the “Set Attribute Single messages to request or set current values of the 5511 Tools Menu. Once the values in Tools_Array_for_HMI and Tools_array_for_HMI2 arrays are edited, they are copied into the Tools_WRITE_Data and Tools_WRITE_Data2 instances so that they may be written back to the 5511.

The Tools Menu services available through the EIP interface are controlled by two (2) control variables, Control_100 and Control_101. Both of these variables are integers and are described below.

Control_100

This variable is a write command and is used to write the updated values of the Tools Menu variables.

Procedure to accomplish this is to first read the current values, then update, and finally write back to updated values. Set this control variable to a value of 1 when ready to write – otherwise set it to 0

Control_101

This variable is a read request and is used to read the most current value of the Tools Menu variables. Set this control variable to any non-zero value when ready to read – otherwise set it to 0.

The procedure for processing Tools Menu variables through the EIP interface in the 5511 is shown below. Review the PLC program (Tools routine), as you read the details below.

Reading the current values of the Tools Menu:

1. The PLC sends a “Set Attribute Single” message, requesting the 5511 to load current Tools Menu values into local registers. Once this message is processed, the PLC then sends a “Get Attribute Single” message in order to read the most current values of the Tools Menu variables into the appropriate PLC tags. See description of this sequence below and review the PLC code in the Tools routine.
 - a. The “Read Current values” request is accomplished by first setting the tag Tools_Read_Control_Word to a value of 1 and the tag Tools_Write_Control_Word to a value of 0, which setup Control_100 and Control_101 for a read request.
 - b. Then the Tools_COPY_to_Write_area bit must be set, which initiates the “Set Attribute Single” message – and the 5511 will respond by loading the current values of the Tools Menu variables into local registers.
 - c. Once the “Set Attribute Single” message is processed, the PLC will set the “Tools_READ_from_TSC_5511_1” bit and the “Get Attribute Single” message will be sent. Once processed, the current values of the Tools Menu will be loaded into appropriate PLC tags.
 - d. At this point, the Tools_READ_Data (and Tools_READ_Data 2) and the Tools_Array_for_HMI (and Tools_Array_for_HMI2) will be loaded with the current values of the 5511 Tools Menu and are ready for viewing/editing.

Writing new values to the Tools Menu):

1. The "Write new values" request is accomplished by first performing a "Read Current values" request detailed in the previous page so that the most current values are loaded into PLC memory so that they can be edited and then updated.
2. Once ready to update the new/modified values, the PLC sends a "Set Attribute Single" message, requesting the 5511 to update the Tools Menu values with the values in the Tools_WRITE_Data (and Tools_WRITE_Data2) tags. Once this message is processed, the PLC then sends a "Get Attribute Single" message in order to confirm that these new values have been written. See description of this sequence below and review the PLC code in the Tools routine.
 - a. The "Write new values" request is started by setting the tag Tools_Read_Control_Word to a value of 0 and the tag Tools_Write_Control_Word to a value of 1, which setup Control_100 and Control_101 for a write request.
 - b. Then the Tools_COPY_to_Write_area bit must be set, which initiates the "Set Attribute Single" message – and the 5511 will respond by saving the values located in the Tools_WRITE_Data (and Tools_WRITE_Data2) tags into the 5511 Tools Menu
 - c. Once the "Set Attribute Single" message is processed, the PLC will set the "Tools_READ_from_TSC_5511_1" bit and the "Get Attribute Single" message will be sent. Once processed, the current values of the Tools Menu will be loaded into appropriate PLC tags.
 - d. At this point, the Tools_READ_Data (and Tools_READ_Data 2) and the Tools_Array_for_HMI (and Tools_Array_for_HMI2) will be loaded with the new values of the 5511 Tools Menu.

EIP Details for Tools, page 1 Instance – Get Attribute messages:

Instance = Tools, page 1
 Instance number = 75
 Class = A2 (Hex)
 Attribute = 5 (Hex)
 Destination Element = Tools_READ_Data structure
 Data length = 208 bytes – data is mixed though

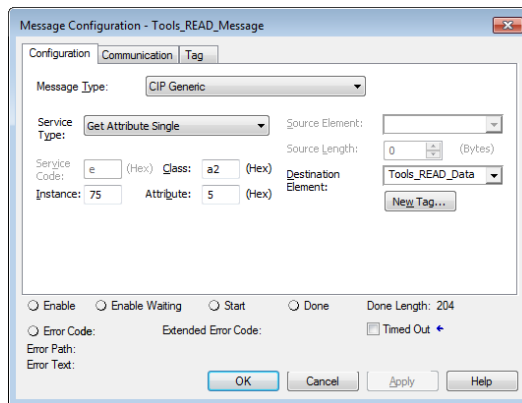

EIP Details for Tools, page 2 Instance – Get Attribute messages:

Instance = Tools, page 2
 Instance number = 76
 Class = A2 (Hex)
 Attribute = 5 (Hex)
 Destination Element = Tools_READ_Data2 structure
 Data length = 208 bytes – data is mixed though

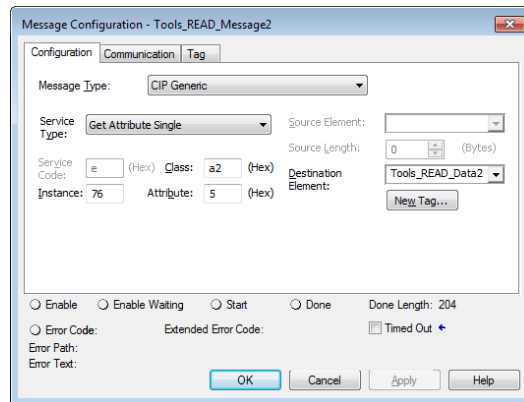
**EIP Details for Tools, page 1 Instance – Set Attribute messages:**

Instance = Tools, page 1
 Instance number = 75
 Class = A2 (Hex)
 Attribute = 5 (Hex)
 Destination Element = Tools_WRITE_Data structure
 Data length = 204 bytes – data is mixed though

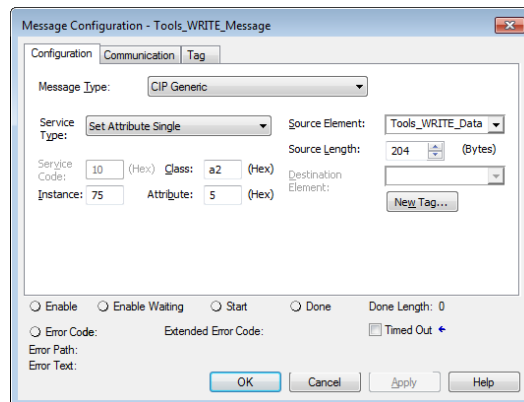

EIP Details for Tools, page 2 Instance – Set Attribute messages:

Instance = Tools, page 2
 Instance number = 76
 Class = A2 (Hex)
 Attribute = 5 (Hex)
 Destination Element = Tools_WRITE_Data structure
 Data length = 204 bytes – data is mixed though

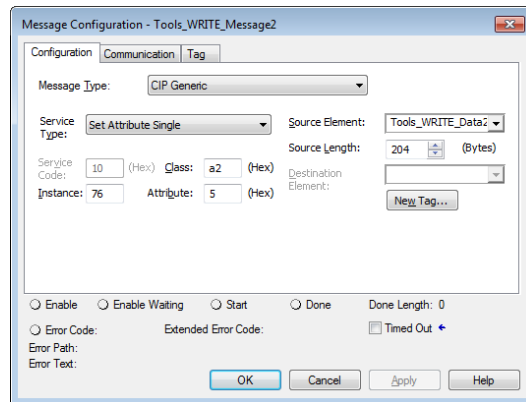
**6.5.4 EIP Interface – Calibration**

The 5511 Scale Controller's EIP interface can be used to perform a Calibration in the 5511 Scale Controller. Performing a Calibration through the EIP interface is facilitated through the use of a user defined data type (UDT). This UDT is a structure that matches the layout of the layout of the calibration variables located in the TSC 5511. This UDT is named TSC_5511_Calibration and multiple instances of this UDT can be used as needed.

The instance used for Calibration is described below:

- Cal_WRITE_Data – used with the “Set Attributes Single” message to request a specific calibration function (Zero or Span).
- Cal_READ_Data – used with the “Get Attribute Single” message to retrieve current status of the 5511 Calibration.

The Tools Menu services available through the EIP interface are controlled by two (2) control variables, Control_100 and Control_101. Both of these variables are integers and are described below.

Cal_Ch_Num_and_Error_bits

This variable selects the channel to be calibrated and also provides feedback in the forms of specific error bits.

Cal_Control_status_bits

This variable selects the function to be performed (Zero or Span) and also provides feedback in the form of status of each function (in progress or done).

The procedure for performing a Calibration through the EIP interface in the 5511 is shown below. Review the PLC program (Calibration routine), as you read the details below.

Performing a Calibration:

1. The Test Weight and Test Weight Units variables must be set before a Calibration is started. These two variables are located in the Tools Menu.
2. The Channel must also be selected before a Calibration is started. The Channel number is encoded in the calibration variable Cal_Ch_Num_and_Error_bits, see below:
 - a. Set the first 3 bits as a binary number 1, 2, 3, or 4 (for Channels 1, 2, 3, or 4)
 - b. So for Channel 1, set to 001 (Channel 2 = 010, Channel 3 = 011, and Channel 4 = 100)
 - c. Leave all other bits off or set to 0
3. Now that the Test Weight, Test Weight Units, and Channel Number have been preset, the Calibration procedure can be started – by calling for a Calibration Zero, where the load cell reading of the empty scale will be measured:
 - e. The “Read Current values” request is accomplished by first setting the tag Tools_Read_Control_Word to a value of 1 and the tag Tools_Write_Control_Word to a value of 0, which setup Control_100 and Control_101 for a read request.
 - f. Then the Tools_COPY_to_Write_area bit must be set, which initiates the “Set Attribute Single” message – and the 5511 will respond by loading the current values of the Tools Menu variables into local registers.
 - g. Once the “Set Attribute Single” message is processed, the PLC will set the “Tools_READ_from_TSC_5511_1” bit and the “Get Attribute Single” message will be sent. Once processed, the current values of the Tools Menu will be loaded into appropriate PLC tags.
 - h. At this point, the Tools_READ_Data (and Tools_READ_Data 2) and the Tools_Array_for_HMI (and Tools_Array_for_HMI2) will be loaded with the current values of the 5511 Tools Menu and are ready for viewing/editing.

Writing new values to the Tools Menu):

4. The “Write new values” request is accomplished by first performing a “Read Current values” request detailed in the previous page so that the most current values are loaded into PLC memory so that they can be edited and then updated.
5. Once ready to update the new/modified values, the PLC sends a “Set Attribute Single” message, requesting the 5511 to update the Tools Menu values with the values in the Tools_WRITE_Data (and Tools_WRITE_Data2) tags. Once this message is processed, the PLC then sends a “Get Attribute Single” message in order to confirm that these new values have been written. See description of this sequence below and review the PLC code in the Tools routine.
 - e. The “Write new values” request is started by setting the tag Tools_Read_Control_Word to a value of 0 and the tag Tools_Write_Control_Word to a value of 1, which setup Control_100 and Control_101 for a write request.
 - f. Then the Tools_COPY_to_Write_area bit must be set, which initiates the “Set Attribute Single” message – and the 5511 will respond by saving the values located in the Tools_WRITE_Data (and Tools_WRITE_Data2) tags into the 5511 Tools Menu

- g. Once the "Set Attribute Single" message is processed, the PLC will set the "Tools_READ_from_TSC_5511_1" bit and the "Get Attribute Single" message will be sent. Once processed, the current values of the Tools Menu will be loaded into appropriate PLC tags.
- h. At this point, the Tools_READ_Data (and Tools_READ_Data 2) and the Tools_Array_for_HMI (and Tools_Array_for_HMI2) will be loaded with the new values of the 5511 Tools Menu.

EIP Details for Tools, page 1 Instance – Get Attribute messages:

Instance = Tools, page 1
 Instance number = 75
 Class = A2 (Hex)
 Attribute = 5 (Hex)
 Destination Element = Tools_READ_Data structure
 Data length = 208 bytes – data is mixed though

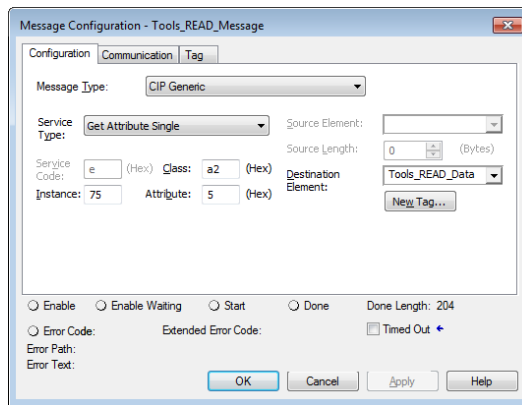

Appendix A

Appendix A

TSC 350 Checkweigher Installation

The TSC 350 checkweigher is a drag chain style checkweigher, using 2 or more parallel sets of flat-link chain to carry packages across a fixed scale section. This style checkweigher is designed for use with rigid packages, such as jars, canisters, boxes or rigid plastic trays.

The length of the scale section is determined by the range of package length or diameter, combined with the required maximum production rate and conveyor speed. Scale sections range in length from 3.5" to 14". The fixed in-feed and out-feed guides provide an entry/exit point for containers, and provide a smooth transition of containers onto and off of the scale section.



WARNING: THIS EQUIPMENT TO BE INSTALLED & SERVICED BY TRAINED PERSONNEL ONLY

7.1 Electrical Installation

Instructions within this manual and attached drawings are to be strictly followed to insure both personnel safety and proper operation of the equipment. Please carefully read these instructions regarding mechanical and electrical installation, and controller configuration before attempting to install or operate this equipment.

7.1.1 Electrical Requirements & Wiring Methods

The Checkweigher system requires 120 VAC power from a dedicated branch circuit breaker rated at **15 Amps Max.** This breaker is to be used as the primary means of disconnecting power from the Checkweigher system when performing maintenance. ***Please practice safety when working on or around this Checkweigher equipment.***

7.1.1.1 Drive System

Drive components for the TSC 350 typically include a mild steel or stainless steel and wash-down rated motorized drive roller. Chain drive sprockets are mounted to the roller. The roller operates on 24VDC and is controlled by a drive module located inside the checkweigher controls enclosure. Speed is adjustable via a potentiometer on the drive module. A proper ground must be maintained from the motorized drive roller to the frame, through the controls to Earth Ground. Check potential of the ground connection to the 120VAC power source Neutral. There should be almost no potential or voltage.

7.1.1.2 Conveyor Mechanical Installation

The TSC 350 Checkweigher is comprised of several components on a common frame; fixed in-feed chain guides, "live" scale chain guides, fixed out-feed chain guides, and chain drive components.

The conveyor system mounts to the floor via adjustable leveling feet that can be adjusted to align the height of the conveying surface with both in-feed and out-feed conveyors. For the highest possible accuracy and product stability it is **critically important** to provide a smooth transition of the package onto and off of the checkweigher conveyor. Installation requirements are:

- **Same height as the in and out feed conveyors**
- **Running at same speed as in and out feed conveyors**
- **Close as possible to in and out feed conveyors pulleys without frames touching.**

HINT: add a small skid transition plate and/or guide to the in-feed section of the scale will make product transfers more stable in situations where conveyors cannot be placed directly adjacent to one another.

The Checkweigher conveyor should be mounted to a rigid and stable surface such as a concrete floor or support structure. All mounting feet should lay flat against the surface. If one corner rocks or a foot doesn't lie flat, adjust the leveling foot to stabilize the conveyor. Once the checkweigher is properly positioned with in-feed and out-feed conveyors, lag the feet to the floor.

It is VERY IMPORTANT NOT to torque or skew the conveyor frame when tightening the mounting bolts. The conveyor should be installed so that the conveyor chain is pulled in the direction of travel.

NEVER ALLOW THE CHAIN TO BE PUSHED. THIS WILL DAMAGE THE CHAIN AND CHAIN TENSION ADJUSTMENT HARDWARE.

The chains are designed to be run in a slack condition when properly adjusted. Running the chains too tight will adversely affect weighing accuracy and system performance as well as the life of the chain.

Proper chain tension can be checked by lifting the chain at the mid-point of the weigh table. You should be able to lift the chain approximately 1" before feeling resistance. If the chain is not properly adjusted, either add or remove chain links to achieve proper tension.

Verify that all drive components are directly in-line with the chain guides. If a drive sprocket or tensioner pulley are out of alignment it will place side load on the chain. This will affect accuracy and the life of the chain.

7.1.1.3 Weigh-Table Installation & Adjustment

The load cell supplied in the TSC 350 are a single-point aluminum or stainless steel load cell with a 2mV/V output, and is available from many sources, including Thompson Scale Co. The capacity of the load cell is dependent upon the application load and container size. Load cells range from 1kg to 10kg. Please contact the factory to discuss any changes in capacity before making the change.

All load cells are provided with a mechanical overload stop. This stop is located directly below the load cell mounting plate at the "live" end of the load cell. The overload stop is a 1/4-20 bolt with a locking nut.

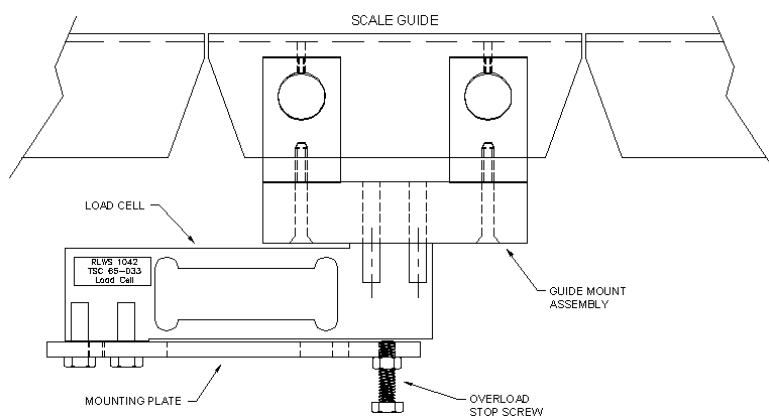

7.1.1.4 Adjusting the Overload Protection Screw

Each load cell is held to the load cell mounting plate by two (2) 1/4-20 threaded bolts screwed into the upstream end of the load cell. Loosening these bolts slightly allows for radial adjustment of the load cell and weigh table, and may be used when aligning the chain guides. Before adjusting the overload stop, confirm that the mounting screws are properly tightened and that the load cell is stable and secure.

When shipping or moving the equipment place the overload stop screw against the bottom of the load cell, then tighten the locking nut to hold the screw in place.

After the checkweigher is installed, back off the overload stop screw and apply a weight equal to 150% of the heaviest product weight to the center of the weigh table. Adjust the overload screw upward until it lightly contacts the bottom of the load cell. Now tighten the locking nut.

When a load greater than 150% of the heaviest product weight is applied to the weigh table, the "live" end of the load cell will contact the overload stop and protect the load cell from damage. This overload stop will NOT protect the load cell from significant shock or mechanical overload or side load in excess of the load cell's capacity.

7.1.1.5 Aligning Chain Guides

Adjusting and aligning chain guides is typically only required during the initial installation. Even with wear, the guides should remain properly aligned.

The set of two chains are properly spaced and designed to carry the product across the scale. Although the chain is extremely light and very flexible, mis-alignment of the in-feed and out-feed guides to the weigh table guides will cause erratic and inaccurate weights.

As the chain travels from the in-feed guide onto the weigh table guide, it can impact the side or bottom of the weigh table guide, causing a disturbance in weight. To properly align guides, using the following procedure:

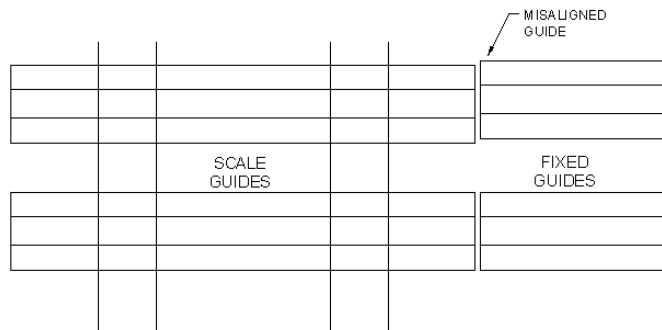
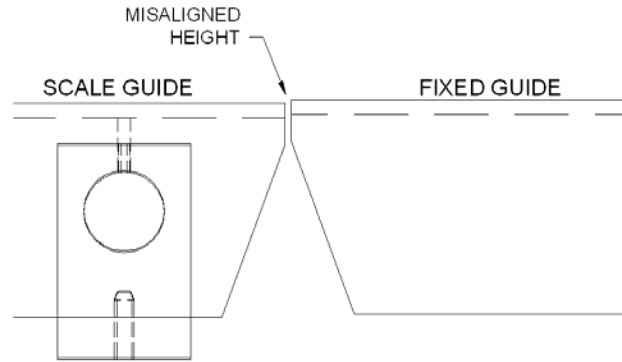

1. Remove the chain from the set of two parallel guides for the weigh table and in-feed/out-feed fixed guides. The chain can be lifted and removed from each end of the conveyor and laid aside.
2. Use a 36" level and place along one of the sets of chain guides. Verify that the in-feed, scale and out-feed guides are level and flat.
3. Using two (2) 3/4" open-end wrenches, place one wrench on the top nut of the fixed guide adjusting rod. Place the other on the bottom nut of the same rod. Loosen the bottom nut slightly. The fixed guides can be raised and lowered using these adjusting rods, but should be very close to the proper height when your system arrives.
4. Using one of the 3/4" wrenches, gently tap on the adjusting rod top nuts to position the guides to match the weigh table guides.

HINT: Use a business card or thin piece of rigid plastic, hold with two fingers and gently run along the bottom of the fixed guide and onto the weigh table. There should be no bump or catch as the edge makes transition from one surface to the other. Hold the piece against the bottom and against either the left or right side of the guide and perform the same test. The piece should again make smooth transition from the fixed guide to the weigh table.

5. Holding the top adjustment rod nut securely with the 3/4" wrench, slowly and carefully tighten the bottom nut to secure the guide in place.

6. Repeat this for all in-feed fixed guides and then for the out-feed guides. If it is not possible to properly align either the in-feed or out-feed guides, loosen the mounting bolts on the bottom of the weigh table load cell and rotate or shift the load cell to move the guides into a better position. Make sure to secure these bolts prior to making any adjustments to the fixed guides.

Once the guides have all been adjusted, replace the chain. Set the checkweigher controller to the "Run" menu and monitor the live weight reading just below the main checked weight value. Turn on the conveyor and observe the weight reading to see if any disturbances appear. Weight value should fluctuate no more than 1 or 2 increments.

7.1.2 Scheduled Maintenance

The TSC 350 Checkweigher requires little more than periodic lubrication and cleaning. Lubrication of the drive shaft bearings is required every 500 Hours of operation (***every 10 weeks, if you run 1 eight-hour shift a day, or every month if you run 3 eight-hour shifts a day***). Lubrication can be any commercially available lube grease, or can be food-grade lube if required for the application.



WARNING: Checkweigher Conveyor & Control Power Should Be Disconnected Before Performing Maintenance On This Equipment. Unexpected Operation of Conveyors or Reject Devices May Occur.

Lubrication should be applied to each bearing with a standard grease gun. Grease should be applied until a small amount of grease begins to escape from the bearing. Excess can be removed with a clean cloth or paper towel. If your application requires wash-down and/or high-pressure wash-down,

LUBE BEARINGS AFTER EACH WASH-DOWN AND/OR MAKE SURE BEARING COVERS ARE IN PLACE.

Bearings that are not lubricated on the above specified schedule will experience undue heat and wear, and may fail. If failure occurs, the drive shaft may become worn or damaged, requiring replacement.

7.1.2.1 Cleaning Conveyor Chain

Conveyor chain can also become coated with spilled product or residue. Depending upon your product and application, it may be necessary to inspect the chain once per week to ensure all chain links are loose and free-moving. Sticky chain will greatly degrade the performance and accuracy of the checkweigher. Nylatron chain can be cleaned with a solvent, such as Varsol, or with a product known to effectively loosen or remove your product. It may be necessary to test a small section of the chain to ensure that no swelling or damage to the chain links occurs.

Other than keeping the equipment clean and free of product build-up, no other maintenance is required.

7.1.2.2 Cleaning Chain Guides

As with the conveyor chain, the guides must be free of product build-up. If build-up is found, use a cleaning agent and possibly a small blade screwdriver or other similar object to manually remove build-up from within the corners of the chain guides. Use caution and ensure that you do not gouge or damage the guides.

Chain guide end caps can also accumulate product, so inspect for both accumulation and wear. If the end caps become worn, they can be easily replaced by purchasing new end caps. There is a 1/16" gap between the fixed chain guides and the weigh table. Carefully inspect this area to ensure that product does not build up and form a bridge between the fixed and "live" portion of the scale. This will affect accuracy.

7.1.2.3 Changing the Load Cell

If damage has occurred to the load cell, and the load cell must be replaced, follow the steps listed below. Refer to the trouble shooting guide in this manual for information on testing the load cell.

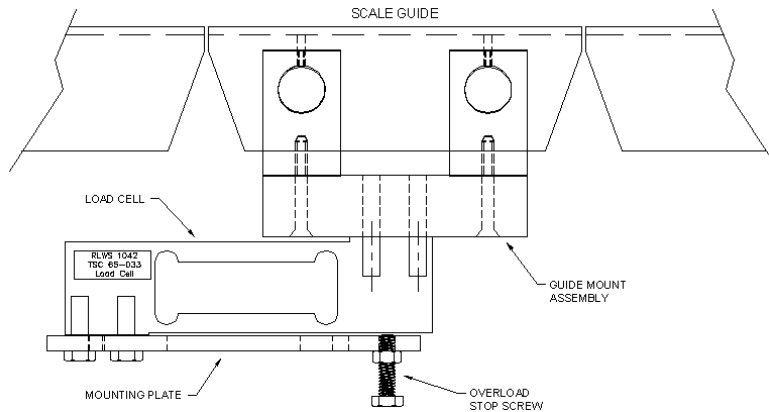

The weigh table is attached by two Allen-head cap screws to the top of the load cell. To replace the load cell:

1. Gently lift the chain from the guides and ease over each end of the in-feed and out-feed chain guides, lay aside.
2. Use an Allen wrench to remove the weigh table from the load cell, place aside
3. Cut the plastic cable tie holding the load cell cable to the load cell mounting platform.
4. Loosen the two 1/4-20 bolts securing the load cell to the load cell mount.
5. Install the new load cell, only hand-tightening the 1/4-20 bolts to temporarily secure the load cell to the mounting plate.
6. Loosen the load cell overload stop retaining nut, and gently turn the overload stop screw in until it makes contact with the load cell. **DO NOT** tighten.
7. Replace the weigh table and gently tighten the Allen-head cap screws. **DO NOT** apply downward pressure or too much torque. This may damage the load cell!
8. Align the weigh table with the in-feed and out-feed guides, as described earlier in this chapter
9. Once the weigh table is properly aligned, tighten the two 1/4-20 bolts to secure the load cell to the mounting plate. Verify that the weigh table and in-feed/out-feed guides are still properly aligned.
10. Re-install chain. Make sure it is not twisted or kinked, and that it lies freely in the chain guides.

ADJUST OVERLOAD STOP SCREW:

Back the overload stop screw away from the load cell. Once the weigh table has been re-installed, back off the overload stop screw and apply two (2) times the test weight value used for calibration to the conveyor, then adjust the overload stop screw up until it touches the load cell. Secure the lock nut, then remove the test weights